

PHILIPS

Xitanium

LED indoor drivers

Linear

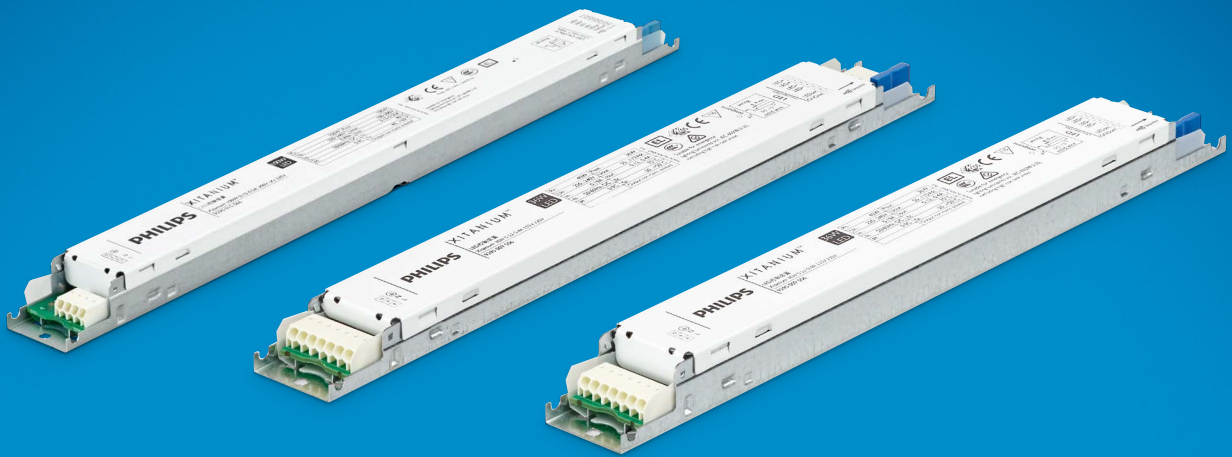

Design-in Guide

Enabling **future-proof** **LED technology** for dynamic LED markets

July 2016

Published versions

28 February 2013 First version

17 May

12 July

30 September

30 January 2014

05 March

17 June

17 December

12 March 2015

20 May

7 October

9 March 2016

24 May

Updated since previous version

- Extended information on driver feature CLO 2.0

- Removed part of the Configurability settings, as these are covered and managed by the MultiOne manual

Contents

Introduction to this guide	4	Thermal design-in	34
Applications	4	Introduction	34
Information and support	4	Tc point	34
Determine which documents contain what information	4	How to... Measure Tc at the Tc point	35
		Driver lifetime	35
		Module Temperature Protection (MTP)	35
Safety precautions	5	Controllability	37
Safety warnings and installation instructions	5	Control characteristics	37
		1-10 V Dimming	38
		TD dimming: Touch and Dim & DALI	38
		Non-dimmable	40
		Application guidelines	40
Introduction to Xitanium Indoor Linear LED drivers	6	Configurability	42
Introduction	6	Philips MultiOne Interface tool	42
Features	7	Settings	43
Energy Meter	12	Philips MultiOne Software	44
Traceability	12	How to... See the programming taking effect	44
OEM Write Protection (OWP)	13	Module Temperature Protection (MTP) behavior setting	45
Form factors	13	Constant Lumen Output setting and CLO 2.0	46
Explanation of the driver naming	13	DCemDIM setting	47
		Corridor Mode setting	48
		How to... Set the DALI minimum dimming level	49
Electrical design-in	14	Quality and Reliability	50
Xitanium Driver Operating window	14	Switching & cycling lifetime of LED drivers	50
How to... Select an appropriate driver	15	Electrical failures due to switching Vmains on and off	50
Driver wiring and connections	15	Mechanical failures due to thermal cycling	50
How to... Use wires and cables	16	Standards the drivers are tested against	52
How to... Connect to a driver with JST connector on output	17		
Adjustable Output Current (AOC) – set the driver output current	18	Disclaimer	53
Default driver output current	18		
How to... Determine AOC priority with TD drivers	19		
How to... Set the output current via Rset	19		
How to... Set the output current via LEDset	21		
How to... Program the output current	26		
Mains voltage fluctuations and behavior	26		
Inrush current	28		
How to... Determine the number of drivers on a MCB	28		
Surge protection	29		
Touch current	29		
Tips on Total Harmonic Distortion (THD)	30		
Electromagnetic compatibility (EMC)	30		
How to... Improve EMI performance	31		
Electrical isolation and protective earth	32		
How to... Use these Indoor Linear LED drivers as “independent” driver	33		

Introduction to this guide



Xitanium Indoor Linear LED drivers

Thank you for choosing Philips Xitanium drivers. In this guide you will find the information needed to integrate these drivers into a LED luminaire or LED system. This edition describes the Xitanium LED drivers optimized for indoor linear lighting. We advise you to consult our websites for the latest up-to-date information.

Applications

Xitanium Indoor Linear LED drivers are designed to be used built-in, and operate LED solutions for indoor lighting like offices, public buildings, industrial applications and retail environments. If you use Philips LED drivers in combination with Philips LED modules, specific design-in guides are available from www.philips.com/technology

Information and support

Downloads and information

Please consult your local Philips office or visit: www.philips.com/technology

Design-in support

On request Design-in support from Philips is available. For this service please contact your Philips sales representative.

Determine which documents contain what information

In order to provide information in the best possible way, Philips' philosophy on product documentation is the following.

- [Commercial leaflet](#) contains product family information & system combinations
- [Datasheet](#) contains the product specific specifications
- [Design-in guide](#) describes how the product is to be designed-in

All these documents can be found on the download page of the OEM website www.philips.com/technology. If you require any further information or support please consult your local Philips office.

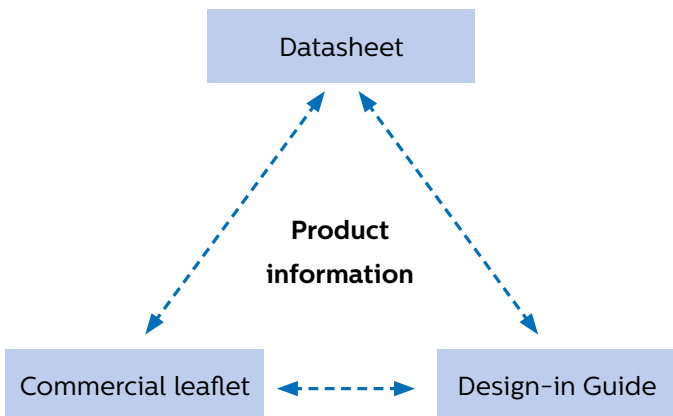

Safety precautions



Warning:

- Avoid touching live parts!
- Do not use drivers with damaged housing and/or connectors!
- Do not use drivers with damaged wiring!
- Class I luminaires must be connected to protective earth!
- An external DC-rated fuse must be used when operated on DC mains!

Safety warnings and installation instructions

To be taken into account during design-in and manufacturing

- Do not use damaged or defective contacts or housings
- Do not use damaged products
- Do not service the driver when the mains voltage is connected; this includes connecting or disconnecting the LED load
- Cap off all unused wires to prevent accidental contact with the luminaire, driver housing or accidental touching
- Do provide an adequate earth connection when applicable
- The luminaire manufacturer is responsible for its own luminaire design and has to comply with all relevant safety standards
- The Xitanium Indoor LED drivers are intended for indoor use and should not be exposed to the elements such as snow, water and ice. It is the luminaire manufacturer's responsibility to prevent exposure.

Philips Design-in support is available; please contact your Philips sales representative.

Introduction to Xitanium Indoor Linear LED drivers



Xitanium Linear LED drivers.
Top showing non- isolated and bottom showing isolated version.

Introduction

Xitanium Linear LED drivers are designed to operate LED solutions for general lighting applications such as linear lighting in offices and in industry applications.

Reliability is underpinned with 5 year warranty, enhanced by specific features that protect the connected LED module, e.g. reduced ripple current (<4%) and thermal de-rating. All Linear LED drivers feature central DC operation.

In the coming years LEDs will continue to increase in efficiency, creating generation and complexity challenges for OEMs. With Xitanium LED drivers, flexibility in luminaire design is assured thanks to an adjustable (selectable) output current. Application-oriented operating windows offer the flexibility required to provide the stable lumen output and light quality levels that lighting specifiers and architects demand. And the adjustable output current also enables operation of various LED PCB solutions from different manufacturers.

The remarkable energy savings and CO₂ reductions achieved with LED lighting can be further extended with dimming. Xitanium Indoor Linear LED drivers offer a range of dimming options. The 1-10 V interface allows for simplified, one-way management, while the DALI interface makes any installation with the Xitanium Linear driver ready for a fully networked control system. Alternatively these Dali drivers also are suitable to interface with Touch and Dim dimming.

Xitanium LED driver versions

The Xitanium LED drivers described in this guide are available in different versions, e.g. both isolated and non-isolated versions, non-dimmable and dimmable (1-10 V and Touch and Dim & DALI (TD)) and come in a wide range of power ratings that enable the most popular light output levels for general lighting applications. We recommend you always check our Xitanium LED driver commercial leaflet for the most up-to-date overview of our range. This leaflet can be found on the download section of www.philips.com/technology.

Features

SimpleSet

Philips SimpleSet new wireless programming technology allows luminaire manufacturers to quickly and easily program Xitanium LED drivers at any stage during the manufacturing process, without a connection to mains power, offering great flexibility. As a result orders can be met faster, while reducing costs and inventory.

For more information, please visit www.philips.com/multiOne or contact your local Philips representative.

Adjustable Output Current (AOC)

Flexibility in luminaire design is ensured by the adjustable output current (AOC). The adjustable output current enables operation of various LED configurations from different LED manufacturers whilst also ensuring the solution remains “future proof” for new LED generations. The output current can be set with an external resistor (referred to as Rset or LEDset). With the TD version drivers the output current setting can also be programmed using the Philips MultiOne hardware interface USB2DALI and the matching MultiOne configurator software. Drivers with SimpleSet functionality can be configured with the Philips MultiOne Software and the SimpleSet interface.

More information about AOC and how to set the output current can be found under chapter “Electrical design”. Information about configuring drivers with SimpleSet can be found in the chapter “Configurability”.

More information on the Philips MultiOne configurator software and hardware interface on www.philips.com/multione.

Controllability

The Xitanium Indoor Linear LED drivers are available in 3 different versions:

- Non-dimmable
- 1-10 V dimming
- Touch and Dim & DALI (TD)

Amplitude Modulation (AM) output dimming

Philips Xitanium indoor linear LED drivers dim the output to the LEDs by means of Amplitude Modulation dimming (AM). This means at no stage of the dimming range Pulse Width Modulation dimming (PWM) at the output to the LEDs is involved. AM dimming guarantees the most smooth and flicker-free operation over the entire dimming range.

The way of controlling is shown in the name of the driver. If no dimming protocol is given in the name, the Xitanium driver can only be used as a non-dimmable driver. The output current can be set as described in the Electrical design chapter. More information about the dimming protocols can be found in the Controllability chapter.

Thermal de-rating

Thermal de-rating of your LED is possible by integrating an NTC (Negative Thermal Coefficient) component on the LED PCB (Printed Circuit Board) and connecting this NTC to the driver's NTC input.

More details about NTC resistor can be found under chapter "Thermal Management".

Module Temperature Protection (MTP) – adjustable on TD drivers only

This feature helps to protect the LEDs when operated in a hot ambient environment. The driver helps to regulate LED module temperature by regulating the output current. An NTC (Negative Temperature Coefficient resistor) must be present on the LED module and connected to associated pins on the driver in order to be able to make use this feature. Programmable drivers allow the dimming behavior to be changed.

Forward current vs T (at NTC)

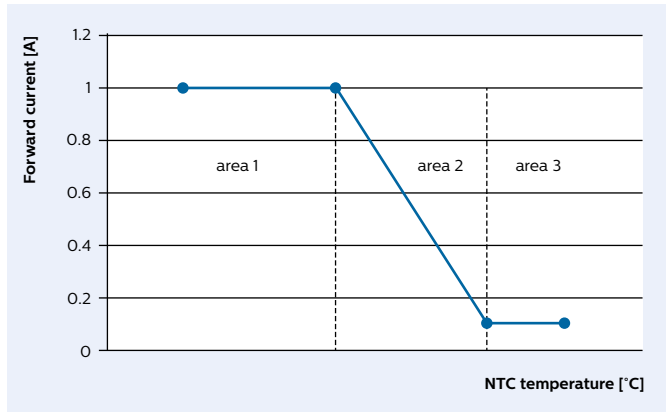

Area 1: temperature of NTC < T_{warn} .

The driver is operating normally, no temperature derating is active.

Area 2: T_{warn} < temperature of NTC < T_{max} .

Temperature derating is active, the LED driver dims down the current linearly between I_{nom} and I_{safe} .

The temperature of the LED board is monitored to adjust the current. When the temperature becomes lower than T_{warn} , the current is back to its normal level.

Area 3: temperature of NTC > T_{max} .

The LED driver limits the current to a specified minimum value, I_{safe} . The temperature of the LED board is monitored to adjust the current (can go back to Area 2 if the temperature decreases below T_{max}).

With the introduction of LEDset the separate NTC input on Linear Indoor drivers has disappeared. MTP provides the functionality of connecting a NTC without the need for a power supply or current source. When this feature is enabled the Rset functionality on the LEDset input of the driver does not work anymore. AOC needs to be programmed through DALI or SimpleSet and the input is no longer LEDset compatible.

The functionality of the LEDset input should be re-programmed that it acts as a thermal derating input. The typical circuit includes a NTC with a parallel resistor. More information on this feature can be found under chapter “Thermal Management”.

Constant Light Output (CLO) – TD drivers only

Traditional light sources suffer from depreciation in light output over time. This applies to LED light sources as well. The CLO feature enables LED solutions to deliver constant lumen output through the life of the light engine. Based on the type of LEDs used, heat management and driver current, it is possible to estimate the depreciation of light output for specific LEDs and this information can be entered into the driver. The driver counts the number of light source working hours and will increase output current based on this input to enable CLO. Since the CLO curve is not generic, the OEM needs to determine the appropriate CLO curve. This can be used to differentiate on e.g. lumen output or power consumption over lifetime. The CLO feature can be programmed with the Philips MultiOne configurator software and requires as input a table which specifies a percentage and a time variables.

CLO 2.0 – simplified

CLO 2.0 offers a simplified, straight forward approach for CLO. A schedule can be created that gradually increases the lamp's power level over time. By configuring the Maximum working hours and the Initial power level a linear schedule is defined which consists of up to 16 scenes (data points). The first scene starts at 0h and at the specified initial power level, which should be lower than the final power level, referred to as 100%. The last scene starts at the specified working hours and at 100% power level.

Note: The reliable use of Constant Light Output requires extensive LED specification assessment of life time behavior of LEDs. The CLO feature can be programmed with the Philips MultiOne configurator software and requires as input a table which specifies a percentage and a time variable.

More information can be found under chapter "Controllability". More information can be found on www.philips.com/multione.

DC mains operation

It is possible to connect the mains input of the Xitanium driver directly to a DC power net (e.g. central emergency system). This leads the driver to continue normal output when switched to DC mains. On selected TD drivers DCemDIM is available, allowing a pre-defined dim level (%) of the driver's output when switched to DC. More on DCemDIM in section Controllability.

When operating a driver on DC mains an additional external DC voltage/current rated fuse must be used because the internal driver fuse is not rated for DC operation.

The fuse should be placed in the "+ line" of DC power supply.

For LED-drivers with a power output of 25W-150W the next fuse parameters are advised.

Voltage rating: 250V DC

Current rating: 1,25A – 2A Slow

I^2t : > 9,75 A²/sec (Melting Integral)

Check for requirements and default values the driver's datasheet in the download section on www.philips.com/technology.

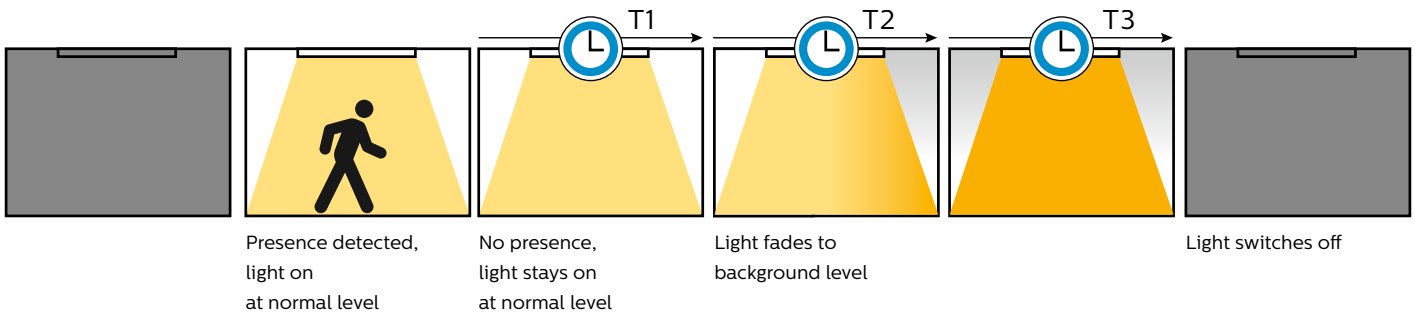

Corridor Mode – TD drivers only

Corridor Mode is typically used in corridors, stairwells, entrance halls, storage rooms, underground car parks, pedestrian underpasses, underground railway stations and lifts. It is a simple function, available with Xitanium indoor linear TD LED drivers, that controls the light level when presence is detected by a simple on/off mains sensor. It is easy to use and can be activated using default parameters, so no programming via software is required.

When the sensor detects presence, the light switches on. When it no longer detects any presence, instead of the light switching off immediately, the TD driver takes over control of the light level and dims it down to a background level. The settings can be customized using the Philips MultiOne configurator software.

How does it work?

A simple on/off mains sensor (e.g. PIR or micro wave) provides the signal and is connected to the Touch and DIM/DALI connection of the TD driver. When the input detects mains power on the DALI connection, it switches on the light to the normal level. When the mains signal of the sensor is switched on for more than 1 minute (default activation time), the TD driver goes into Corridor Mode.

When the on/off sensor no longer detects any movement, it goes into its delay time. After the delay time of the on/off sensor has elapsed, the TD driver no longer receives a mains signal on the DALI input and takes over control of the light level by going into its Corridor Mode sequence:

1. During the delay time the driver maintains the light at the normal level
2. During the fade time the driver dims the light to the background level
3. During the prolong time the driver maintains the light at the background level, after which the light is switched off.

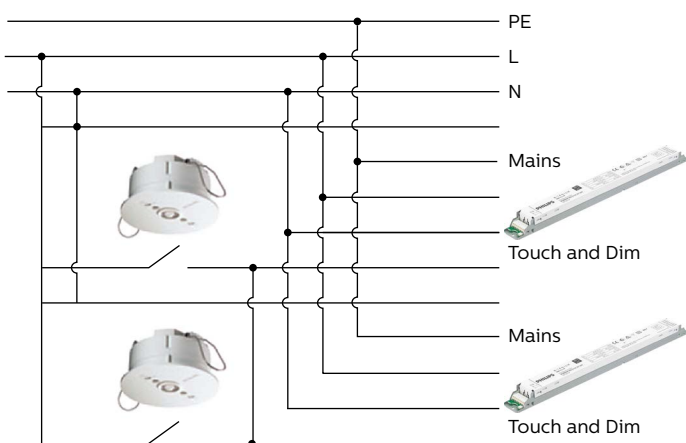

Connecting a sensor to the Dali input to utilize Corridor Mode

If the on/off sensor detects movement at any point during the Corridor Mode sequence, the light will revert to the normal level.

Newly released Xitanium indoor linear TD drivers incorporate the Corridor Mode feature. The datasheet states if for the driver you use this feature is present. For the default settings please check the associated datasheet of the driver you use, to be found in the download section on www.philips.com/technology.

The settings can be customized to suit your application using the Philips MultiOne configurator software (see sub section “Programming” under “Controllability”).

Driver diagnostics (actual measurements and logging) – TD drivers only

On selected TD drivers the diagnostics functionality is available. The purpose of Diagnostics is to gather information and help diagnose the history of the driver and connected LED module. The diagnostics consist mainly of counters which keep track of specific variables like for example the number of startups of the driver, temperature of driver and LED modules, current and voltages etc.

When the driver is shutdown the diagnostics data is stored automatically.

Energy Meter

This feature provides an indication of the (total) energy consumption of the device. Several values can be read; the actual power currently drawn, the total power consumption over life (from 0h) and the power consumption since last reset.

Traceability

The Traceability tab summarizes how many times the configuration of the device was changed, when the last configuration change happened using unknown software and a pane showing details of the first, second and last configuration change (if present). Every entry in the list shows the date of the configuration change, which software version was used and which type of interface was used at the time of the configuration change.

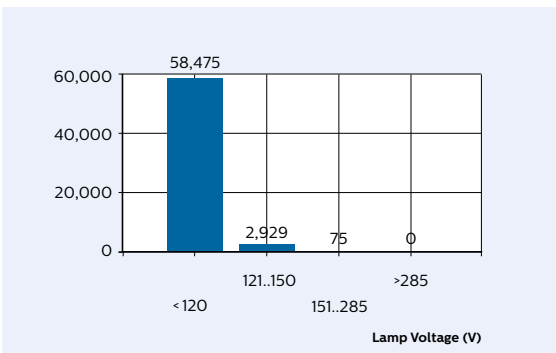
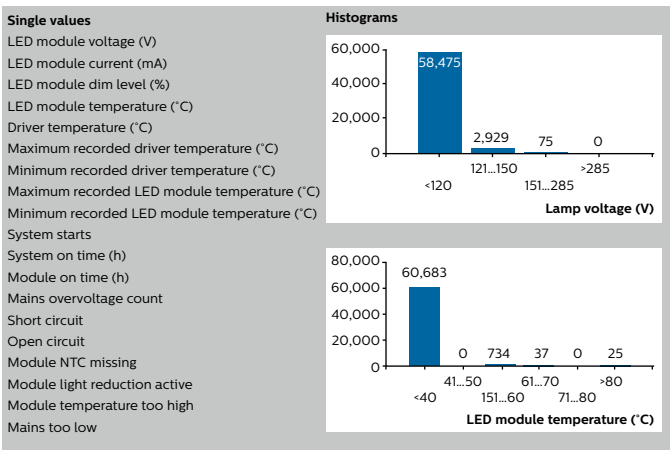

OEM Write Protection	
Summary	OEM Write Protected features
DALI PSU	<input type="checkbox"/> (De)select all
ALO	<input type="checkbox"/> DALI PSU
AOC	<input type="checkbox"/> ALO
OWP	<input checked="" type="checkbox"/> ALO Min
ECO FactoryLink	<input checked="" type="checkbox"/> AOC
	Set the OEM Write Protection password
New password:	<input type="text" value="**"/> <input type="text" value="*"/> <input type="text" value="*"/> <input type="text" value="**"/>
Verify password:	<input type="text" value="**"/> <input type="text" value="*"/> <input type="text" value="*"/> <input type="text" value="**"/>
	The password must contain 4 numbers (0-255).

OEM Write Protection (OWP)

OEM Write Protection (OWP) defines a password that will be set in the driver so the data of OEM Write-protected features can only be written to the driver by providing the configured password. Reading the properties is possible without the need of the password.

Once a password is configured into the device, it is necessary to provide the current password when writing other features that are OEM Write-protected. These features are indicated by a padlock icon in the Write screen in MultiOne software. When the OWP feature is activated it is not possible to retrieve the currently configured password.

Form factors

Linear housing

The housing of the Xitanium Indoor Linear LED drivers has a form factor compatible with typical fluorescent driver housing design.

Explanation of the driver naming

The names of the drivers are defined as shown in the example below.

Example : Xitanium 75 W/0.12-0.4 A 215 V TD 230 V

Xitanium : brand name for highly efficient and extremely reliable LED drivers

75 W : maximum output power

0.12-0.4 A : output current range

215 V : maximum DC output voltage

TD : dimming protocol (Touch and Dim & DALI)

230 V : mains AC input voltage

Electrical design-in

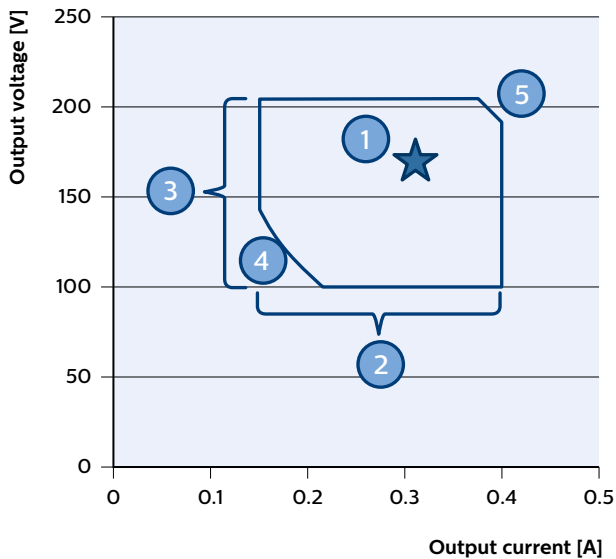

1. Required set point for the LED solution
2. Current can be set to needs within range
3. Driver adapts to required voltage, given it fits range
4. Driver minimum power limit
5. Driver maximum power limit

Example of a Driver Operating Window

Note: by means of dimming it is possible to go below the minimum value of the specified output current.

Xitanium Driver Operating window

LED technology is rapidly evolving. Using more efficient LEDs in a next generation means the same light output can be achieved with less power, hence lower drive currents. At the same time, LEDs can be driven at different currents levels based on the application requirement. Typically, LED drivers are available in discrete current levels e.g. 350 mA, 500 mA or 700 mA. It is often necessary to replace a driver when more efficient LEDs or different LED boards become available.

One of the key features of the Xitanium LED drivers is the adjustable output current (AOC), offering flexibility, differentiation for the OEM and future-proof luminaire design. The Xitanium drivers can operate in a so called “operating window”. This power window is defined by the maximum and minimum voltage (V), current (A) and power (W) that the driver can handle. An example of an operating window is shown on the left. The area indicates the possible current /voltage combinations. The current you select will depend on the type and manufacturer of the LEDs, the specific LED configuration of the PCB design and the desired output (lm) per LED. The voltage is the sum of the LEDs used (total Vf string). Both the operating window and default current setting of every driver can be found in the datasheets in the download section on www.philips.com/technology.

The output current of these drivers can be set in the following ways.

1. By connecting a specific resistor value to the driver’s Rset input.
2. Drivers with SimpleSet functionality can be configured using the Philips MultiOne software and SimpleSet interface.
3. TD driver versions can be programmed via the MultiOne interface in order to set the desired current, more information can be obtained at www.philips.com/multiOne

* Note: when connecting Philips LED Lines to the driver, the type of LED board (**LV** or **HV**) determines this requirement. **Hybrid** LED boards can be used on both type of drivers, indicated in **commercial leaflet LED Lines**, to be found in the download section of www.philips.com/technology

Note: for Philips LED Lines standard system configurations, driven at nominal current, are stated in the **commercial leaflet LED Lines, to be found in the download section of www.philips.com/technology

Note: for a HV scenario that allows a 2 chain parallel solution, you are likely to find with steps described a lower rated driver power (e.g. 75 W for 1 chain versus 36 W for 2 chain solution)

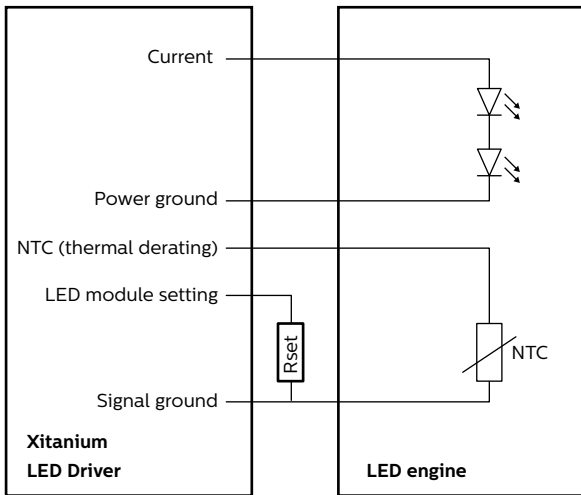

Schematically representation of the driver's output interfaces

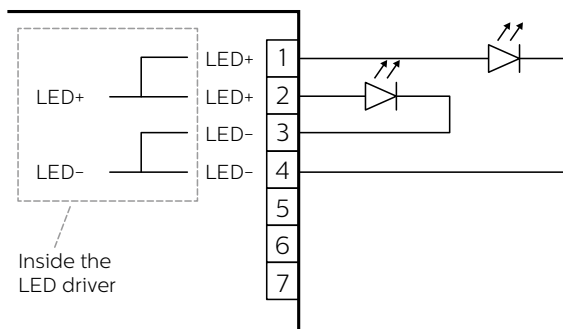

Inside the driver the double-output fitted drivers are inter connected to a single channel

How to... Select an appropriate driver

Depending on your requirements several drivers can be found as a solution for you. The following steps can help selecting the preferred driver.

For a full overview of available driver models, please refer to the commercial leaflet Xitanium indoor linear LED drivers, to be found in the download section of www.philips.com/technology, as are the datasheets associated with the drivers you intend to use.

1. Determine your required drive current (I_{drive}) and voltage (V_f)
2. Calculate required power via $P_{drive} = V_f \times I_{drive}$ (W)
3. Determine which type* of driver do you need; Isolated or Non-isolated
Collect the associated datasheets from the website.
4. Does required current fit current range of driver?
- $I_{driver\ minimum} \leq I_{drive} \leq I_{driver\ maximum}$?
5. Does required voltage fit voltage range of driver?
- $V_{driver\ minimum} \leq V_f \leq V_{driver\ maximum}$?
6. Does required power fit power range of driver?
- $P_{driver\ minimum} \leq P_{drive} \leq P_{driver\ maximum}$?
7. Choose your type** of dimming (TD/Dali, 1-10 V or non-dimmable)

Driver wiring and connections

Examples of driver lead wires with corresponding functions can be seen in the figure on the left. Please check the driver's pinning in the associated datasheet on www.philips.com/technology. The function of each wire will be discussed further in detail in the following chapters.

Single channel driver

Currently all the Xitanium Indoor Linear LED drivers are single channel drivers. This means for drivers with a double "+" and "-" output that these outputs are in parallel inside the driver (see image on the left). So you can only set one current.



Examples of what solutions could look like for pairing wires

How to... Use wires and cables

In the datasheet of the driver you use it is stated what

- Wire diameters are accepted
- Strip length of the wires are accepted
- Up to what wire length the drivers are tested on EMC

Direct wiring between driver and LED boards

Be informed that no components are allowed between the LED driver and LED boards other than connectors and wiring intended to connect the LED driver to the LED board. For example it is not allowed to install a switch between the driver and LED boards.

2 wires into one connector hole

In some scenarios two wires need to be connected to one connector hole. In this case the pairing has to be done outside the driver, resulting in only one wire going into the driver. Two wires into one connector hole are not supported.

Ferrules

The reliability of twin-wire ferrules (or wire end stop), accepting the wires intended to use, should be checked with the supplier of these ferrules.



How to... Connect to a driver with JST connector on output

Some Xitanium Indoor Linear LED Drivers carry a JST output connector (non-isolated models only). Until these drivers get updated with a push-in connector be advised to use the JST-to-push-in adapter.

1. Connecting the LED board to the adapter

On the adapter IDC HV (+) and PGND (-) are indicated (pin 1 and 3). Connect IDC HV (+) to LED board IN+, PGND (-) to LED board IN-.

2. Placing the Rset component into the adapter

- Rset2: place resistor into Rset2 connections (SGND and ISET2, pin 7 and 6).
- Alternatively, when using Rset1: place resistor into Rset1 connections (SGND and ISET1, pin 7 and 5).

3. Wire diameters accepted by the adapter

- AWG 24-16
- 0.2-1.5 mm² solid and stranded
- 0.25-1 mm² with ferrule
- Lead wires of the resistor component

Ordering information can be found in the **Commercial Leaflet of the Xitanium** indoor linear LED drivers, located in the download section on www.philips.com/technology.

JST cable developed by OEM

Any luminaire design needs its own approval, organized by the responsible OEM, irrespective of the length of cable used. If you prefer to develop a JST-cable the specification should meet IEC/EN requirements. When selecting wiring, it must be borne in mind that the cable must not emit hazardous gases or catch fire when exposed to high temperatures (e.g. PVC, Halogen).

The following cable/connector specifications can be used, using a JST connector:

- housing JST PAP-07V-S
- contact JST SPHD-001T-P0.5
- diameter of the cable: 24AWG

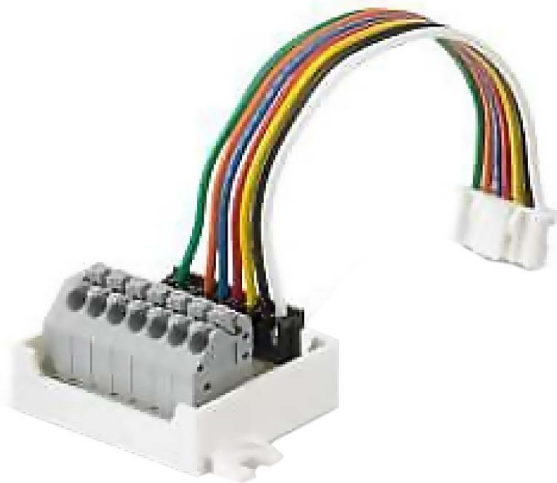

Example of the JST to Push-in adapter

Pin	Color	Function
1	White	IDC HV (+) (LED +)
2	Black	IDC LV (+) (not used for linear)
3	Yellow	Power Ground (-) (LED -)
4	Red	NTC
5	Blue	Iset1 (Rset1)
6	Orange	Iset2 (Rset2)
7	Green	Signal Ground (for NTC & Rset)

Adjustable Output Current (AOC) – set the driver output current

Output current can be set by placing an external resistor (LEDset and Rset) into the driver's Rset input. Next to that TD driver versions allow also setting of the output current via software configuration.

Note: Rset is used as generic indication for Rset1, Rset2 or LEDset.

Note: LEDset and Rset-interface are not meant to be used as a control or dimming interface (for instance 1...10 V). If this is not observed, both performance and safety requirements of the installation may be affected.

Default driver output current

Because of safety requirements Philips decided to structurally implement the minimum output current as default setting for Philips' LED drivers. In addition the LED driver will go into a safe state if the Rset resistor is not functioning well (e.g. broken or disconnected). However, as a result of the LEDset standard the default minimum is not an absolute minimum current anymore. For instance, for linear LED drivers a minimum of 120mA will now become $\leq 120\text{mA}$. Reason for this specification (" \leq " means 'equals or less than') is to allow thermal derating functionality on the LED module, which is part of the new LEDset standard. An 'open' situation (no resistor placed) should therefore be avoided.

In case the LEDset connections are being short circuited, the output of the driver will go to the maximum output power (Pout-max). In this case the required Vf of the LED load defines if at Pout-max also the maximum output current (I-max) is reached. The accuracy in this situation is less than when using a resistor to select and set the output current. An excess in this case are the non-isolated 36W and 75W Fixed Output drivers, potentially reaching up to 133% I-max (530mA).

Strong advice is to always use a well-connected resistor, which will result in a well-defined output current.

Programming enabled		Yes		No	
		Yes		No	
I _{nom} = Programmed value		Rset connected		No	
		Yes		No	
		I _{nom} = Rset Determined value		I _{nom} = I _{default}	
Driver output current I _{nom} should always be					
$I_{\text{driver min}} \leq I_{\text{nom}} \leq I_{\text{driver max}}$					

Priority selection criteria for Group 1 - 1% minimum dim level

How to... Determine AOC priority with TD drivers

Since the TD drivers allow several methods to set the output current (AOC), it is good to take note of the priority of each method with respect to the other.

Historically there are two groups of TD drivers; those which can dim down to 1% (newer) and those which can dim down to 10% (older).

Group 1: 1% minimum dim level (newer drivers)

AOC programming (including SimpleSet) has priority over Rset. For the priority selection criteria see table on the left.

Group 2: >1% minimum dim level (older drivers, 5% or 10% minimum dim level)

The value that sets the lowest current has priority over the other.

1. I_{programming} < I_{Rset} ? => priority for I_{programming}
2. I_{Rset} < I_{programming} ? => priority for I_{Rset}

E.g. programming 200 mA has priority over Rset which would generate 250 mA.

And Rset that generates 200 mA has priority over programming 250 mA.

Note: default current is stated in the driver's datasheet in the download section on www.philips.com/technology.

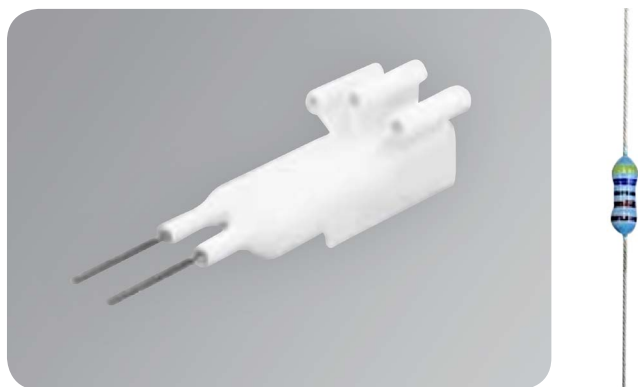

Example of a Set'n'drive resistor featured by BJB, fitted with a leaded resistor inside and allowing both manual or robot placement

How to... Set the output current via Rset

Your lumen, your current

1 resistor value generates 1 current only at all window drivers as long as it fits within the driver window. That is 1 philosophy for all window drivers.

Why a resistor?

- a) Worldwide standardized building block
- b) Worldwide availability and well documented
- c) Freedom for OEM to choose the value and supplier

Resistor placed into driver enables you to

1. Connect different configurations, not just a unique solution
2. Drive different type of LED boards, not restricted to one type
3. Select and tune the current, hence flux or T_c



Example of an Rset2 resistor placed into an isolated driver

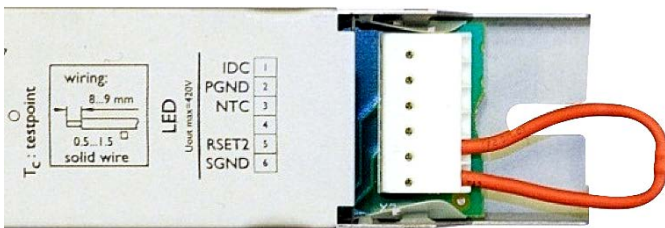

Example of an insulated Rset2 resistor into a non-isolated driver

Resistor characteristics

By making use of a resistor component with a determined Ohm value you can set the required current for your LED module. This component can be a leaded standard 1% tolerance resistor of e.g. 0.125 W or 0.25 W, 50 V. Rset will not be part of the electrical chain driving the LEDs, meaning it does not dissipate power.

However, make sure it does not come into contact with the driver's housing. For safety reasons with non-isolated drivers the resistor must be insulated. Advice is to always insulate the resistor.

Examples of a resistor placed into the drivers' input is shown on the left.

Different Rset resistors are utilized in the Indoor Linear LED driver portfolio;

- Rset1 (older drivers); allows output current setting up to 700 mA
- Rset2; allows output current setting up to 2000 mA
- LEDset; industry standard, allows current setting up to 8000mA In all documentation.

Rset may refer to Rset1, Rset2, or LEDset depending on the driver type. Please check the **driver datasheet** for which Rset the driver you use reads.

Note: While inserting the resistor, please refer to the image on the left. The resistor must be inserted such that there is no possibility of a short caused by the leads. Especially when using non-isolated drivers, make sure the leads of the resistor are insulated. This way they cannot generate a potential safety risk, nor can the trip the earth leakage circuit breaker.

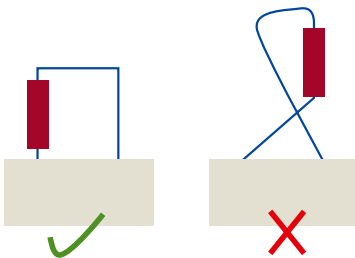

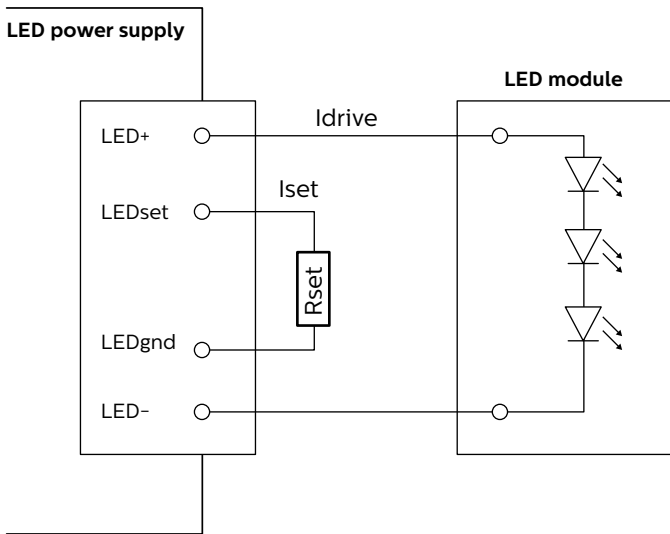

Rset resistor mounted directly onto the driver

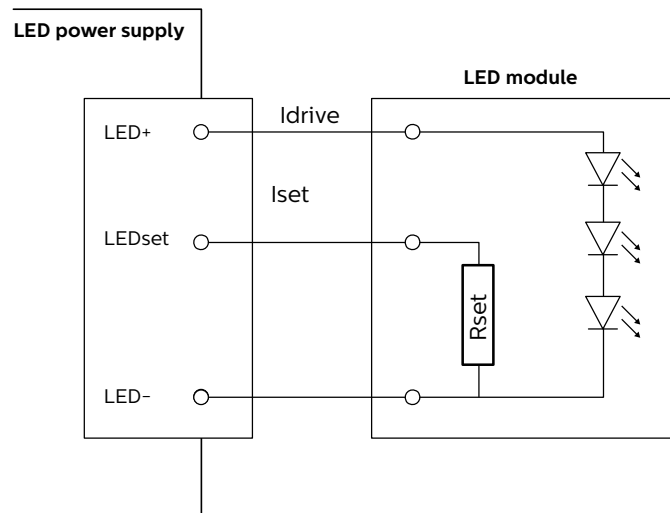

Rset resistor mounted onto the LED module

Rset1 and Rset2 use different pins on the driver (and on the JST connector).

The Rset1 and Rset2 values with the corresponding drive currents are shown in following tables. It is advised to select the nearest lower resistor value that is available to you, if the exact determined value is not at hand.

How to... Set the output current via LEDset

Rset 1 and Rset 2 have been the traditional ways to set the current in the Xitanium window drivers. Next generation drivers will now be introduced with LEDset. LEDset is introduced by several vendors in the market to provide an industry standardized Rset interface. LEDset is, in essence, like Rset1 and Rset2, where one resistor value leads to one output current value only, differing only in the look-up table. Please find the table for E96 resistor values in the next section.

What does LEDset offer

Like Rset1 and Rset2, LEDset is an analogue interface, allowing basic output current setting. The interface supports the following functions:

- Output current setting of the constant current LED driver to LED modules
- Thermal protection of the LED module(s) via thermal dynamic resistors circuit

For more in depth details and further reading, please visit the Module-Driver Interface Special Interest Group (MD-SIG) at their website <http://md-sig.org/>. The specification can be found in the PDF [here](#).

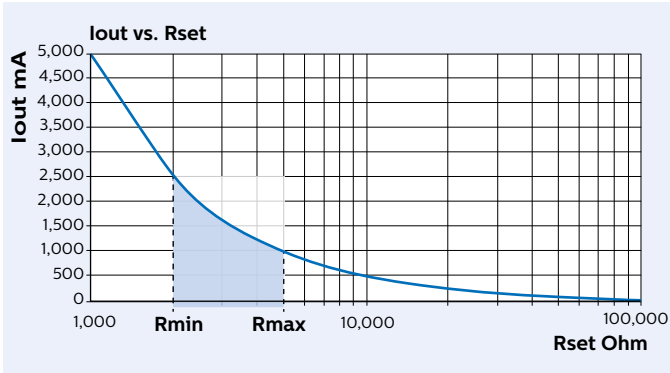

How does LEDset work

LEDset is based on a 3 wire connection between LED driver and one or more LED modules as shown in the figure on the left. Only one additional wire, besides the two LED current supply wires, is used for transferring information from the LED module(s) to the LED driver, provided the Rset is mounted on the LED module.

Alternatively a standard resistor can be put directly into the driver's LEDset input connectors.

The LEDset interface measures the current I_{set} which flows from a 5V constant voltage source within the LED driver through the setting resistor(s) R_{set} which is/are located either on the LED modules or directly into the driver's R_{set} -input.

The current I_{set} flowing through one setting resistor R_{set} is determined by the equation:

$$I_{set} [A] = 5 [V] / R_{set} [\Omega]$$

A LED driver with LEDset interface is able to measure I_{set} and to set the LED driver output current I_{drive} dependent on the measured value of I_{set} according to the equation

$$I_{drive} = I_{set} \times 1000 [A]$$

Therefore the overall relationship between the setting resistor and the LED driver output current I_{drive} is then given by

$$I_{drive} [A] = (5 [V] / R_{set} [\Omega]) \times 1000$$

To calculate the required resistor value for a desired drive current I_{drive} use:

$$R_{set} [\Omega] = (5 [V] / I_{drive} [A]) \times 1000$$

The LEDset interface is intended to cover a LED driver output current range from 0.05 A to 8 A. The corresponding resistor R_{set} is therefore within the range 100 kOhm to 625 Ohm.

In addition, it is possible to add an over temperature protection circuit on the LED module which decreases the setting current in case of an over temperature event and thus limits or folds back the LED driver output current.

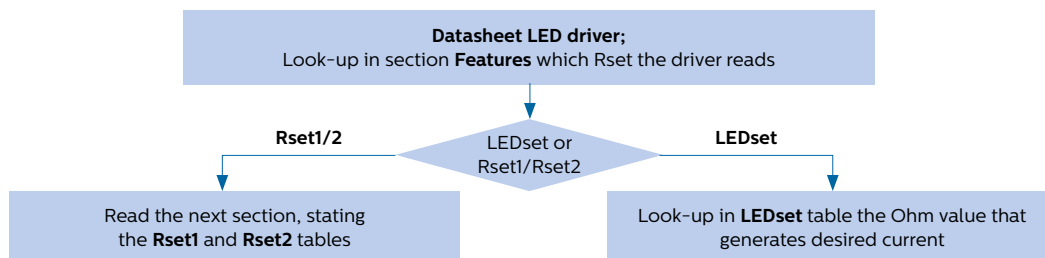

Note on E-series: in electronics, international standard IEC 60063 defines preferred number series for amongst others resistors. It subdivides the interval between subsequent values from 1 to 10 into 6, 12, 24, 48, 96 etc. steps. These subdivisions ensure that when some arbitrary value is replaced with the nearest preferred number, the maximum relative error will be on the order of 20%, 10%, 5%, 1% etc.

LEDset – E96 series: table with E96 resistor values

LEDset [Ω]	Idrive [mA]	LEDset [Ω]	Iset [mA]	LEDset [Ω]	Iset [mA]	LEDset [Ω]	Iset [mA]
open	avoid*	23700	211	11000	455	5110	978
49900	100	23200	216	10700	467	4990	1002
48700	103	22600	221	10500	476	4870	1027
47500	105	22100	226	10200	490	4750	1053
46400	108	21500	233	10000	500	4640	1078
45300	110	21000	238	9760	512	4530	1104
44200	113	20500	244	9530	525	4420	1131
43200	116	20000	250	9310	537	4320	1157
42200	118	19600	255	9090	550	4220	1185
41200	121	19100	262	8870	564	4120	1214
40200	124	18700	267	8660	577	4020	1244
39200	128	18200	275	8450	592	3920	1276
38300	131	17800	281	8250	606	3830	1305
37400	134	17400	287	8060	620	3740	1337
36500	137	16900	296	7870	635	3650	1370
35700	140	16500	303	7680	651	3570	1401
34800	144	16200	309	7500	667	3480	1437
34000	147	15800	316	7320	683	3400	1471
33200	151	15400	325	7150	699	3320	1506
32400	154	15000	333	6980	716	3240	1543
31600	158	14700	340	6810	734	3160	1582
30900	162	14300	350	6650	752	3090	1618
30100	166	14000	357	6490	770	3010	1661
29400	170	13700	365	6340	789	2940	1701
28700	174	13300	376	6190	808	2870	1742
28000	179	13000	385	6040	828	2800	1786
27400	182	12700	394	5900	847	2740	1825
26700	187	12400	403	5760	868	2670	1873
26100	192	12100	413	5620	890	2610	1916
25500	196	11800	424	5490	911	2550	1961
24900	201	11500	435	5360	933	2490	2008
24300	206	11300	442	5230	956	short	avoid**

* driver's default current, however not stable. For details see section on 'Default driver output current'

** driver's maximum current, however not absolute. For details see section on 'Default driver output current'

Datasheet LED driver;
Look-up in section **Features** which Rset the driver reads

If both Rset1 and Rset2 are supported,
Rset2 is advised for future compatibility

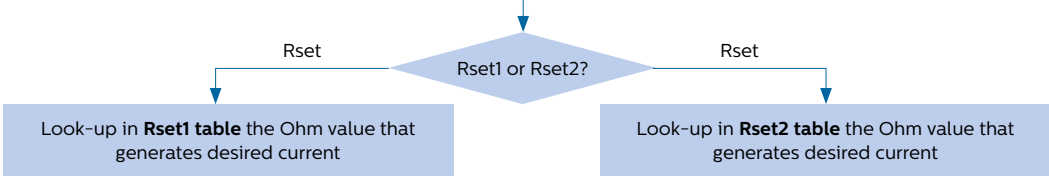

Note on E-series: in electronics, international standard IEC 60063 defines preferred number series for amongst others resistors. It subdivides the interval between subsequent values from 1 to 10 into 6, 12, 24, 48, 96 etc. steps. These subdivisions ensure that when some arbitrary value is replaced with the nearest preferred number, the maximum relative error will be on the order of 20%, 10%, 5%, 1% etc.

Note: next page shows extended Rset2 table: E96 values, stating smaller increments

Rset1 – E24 series

Ret1 [Ω]	Iset [mA]	Ret1 [Ω]	Iset [mA]	Ret1 [Ω]	Iset [mA]	Ret1 [Ω]	Iset [mA]
39	200	510	292	6k8	583	91k	690
43	201	560	300	7k5	591	100k	691
47	202	620	309	8k2	599	110k	692
51	203	680	318	9k1	60	120k	693
56	204	750	327	10k	614	130k	693
62	206	820	336	11k	621	150k	695
68	208	910	347	12k	627	160k	695
75	209	1k	358	13k	632	180k	696
82	210	1k1	369	15k	640	200k	696
91	212	1k2	379	16k	643	220k	697
100	215	1k3	388	18k	649	240k	697
110	217	1k5	406	20k	654	270k	698
120	219	1k6	414	22k	658	300k	698
130	221	1k8	429	24k	661	330k	698
150	226	2k	442	27k	665	360k	699
160	228	2k2	455	30k	669	390k	699
180	232	2k4	466	33k	671	430k	699
200	236	2k7	481	36k	674	470k	699
220	240	3k	494	39k	676	510k	699
240	244	3k3	505	43k	678	560k	700
270	250	3k6	517	47k	680	620k	700
300	256	3k9	525	51k	682	680k	700
330	261	4k3	536	56k	683	750k	700
360	267	4k7	546	62k	685	820k	700
390	272	5k1	555	68k	686	910k	700
430	279	5k6	564	75k	688	1M	700
470	286	6k2	574	82k	689	No Rset	default

Rset2 – E24 series

Ret1 [Ω]	Iset [mA]	Ret1 [Ω]	Iset [mA]	Ret1 [Ω]	Iset [mA]	Ret1 [Ω]	Iset [mA]
short	100	430	245	2k	733	9k1	1558
100	100	470	261	2k2	780	10k	1604
110	106	510	277	2k4	823	11k	1653
120	111	560	297	2k7	884	12k	1694
130	116	620	318	3k	941	13k	1730
150	121	680	340	3k3	993	15k	1793
160	130	750	368	3k6	1042	16k	1817
180	13	820	392	3k9	1086	18k	1864
200	146	910	422	4k3	1143	20k	1902
220	155	1k	452	4k7	1192	22k	1935
240	166	1k1	485	5k1	1238	24k	1965
270	176	1k2	515	5k6	1293	27k	2000
300	190	1k3	545	6k2	1350	No Rset	default
330	204	1k5	602	6k8	1402		
360	215	1k6	632	7k5	1454		
390	228	1k8	684	8k2	1503		

Rset priority behavior for drivers that read both Rset1 and Rset2

Rset1	Rset2	Driver status
Open	Open	Driver's default current (see datasheet)
Rset	Open	Rset1
Open	Rset	Rset2
Rset	Rset	Rset2
Short	Open	Rset1 (driver's minimum current, see datasheet)
Short	Short	Rset2 (driver's minimum current, see datasheet)
Open	Short	Rset2 (driver's minimum current, see datasheet)

Please refer to the datasheet of the driver you use to find which Rset or Rsets the driver actually reads.

Rset2 – E96 series: table with E96 resistor values, stating smaller increments but covering same range as the E24 series on previous page

Rset2 [Ω]	Iset [mA]	Rset2 [Ω]	Iset [mA]	Rset2 [Ω]	Iset [mA]	Rset2 [Ω]	Iset [mA]	Rset2 [Ω]	Iset [mA]	Rset2 [Ω]	Iset [mA]
short	min.	255	171	665	335	1740	669	4530	1171	11800	1686
100	100	261	173	681	341	1780	679	4640	1185	12100	1698
102	101	267	175	698	347	1820	689	4750	1198	12400	1708
105	103	274	178	715	354	1870	701	4870	1212	12700	1719
107	104	280	181	732	361	1910	711	4990	1226	13000	1730
110	105	287	184	750	368	1960	724	5110	1239	13300	1739
113	107	294	187	768	374	2000	733	5230	1253	13700	1752
115	108	301	191	787	381	2050	745	5360	1267	14000	1761
118	110	309	194	806	387	2100	757	5490	1281	14300	1771
121	111	316	197	825	394	2150	768	5620	1295	14700	1783
124	113	324	201	845	400	2210	782	5760	1308	15000	1793
127	115	332	204	866	407	2260	793	5900	1322	15400	1802
130	116	340	207	887	414	2320	806	6040	1335	15800	1812
133	118	348	210	909	422	2370	817	6190	1349	16200	1822
137	119	357	214	931	429	2430	829	6340	1362	16500	1829
140	120	365	217	953	436	2490	841	6490	1375	16900	1838
143	122	374	221	976	444	2550	853	6650	1389	17400	1850
147	123	383	225	1000	452	2610	865	6810	1403	17800	1859
150	125	392	229	1020	459	2670	877	6980	1415	18200	1867
154	127	402	233	1050	469	2740	891	7150	1428	18700	1877
158	129	412	237	1070	475	2800	903	7320	1441	19100	1885
162	131	422	241	1100	485	2870	916	7500	1454	19600	1894
165	132	432	246	1130	494	2940	929	7680	1467	20000	1902
169	134	442	250	1150	500	3010	943	7870	1480	20500	1910
174	136	453	254	1180	509	3090	956	8060	1493	21000	1918
178	137	464	259	1210	518	3160	968	8250	1506	21500	1926
182	139	475	263	1240	527	3240	982	8450	1518	22100	1936
187	141	487	268	1270	536	3320	996	8660	1531	22600	1943
191	143	499	273	1300	545	3400	1009	8870	1544	23200	1952
196	145	511	278	1330	554	3480	1022	9090	1557	23700	1960
200	146	523	282	1370	565	3570	1037	9310	1569	24300	1968
205	148	536	287	1400	574	3650	1049	9530	1580	24900	1975
210	151	549	292	1430	582	3740	1062	9760	1592	25500	1982
215	153	562	297	1470	594	3830	1075	10000	1604	26100	1989
221	155	576	302	1500	602	3920	1088	10200	1614	26700	1996
226	158	590	307	1540	614	4020	1103	10500	1629	27000	2000
232	161	604	313	1580	626	4120	1117	10700	1639	open	default
237	164	619	318	1620	638	4220	1131	11000	1653		
243	167	634	323	1650	645	4320	1145	11300	1666		
249	169	649	329	1690	656	4420	1158	11500	1674		

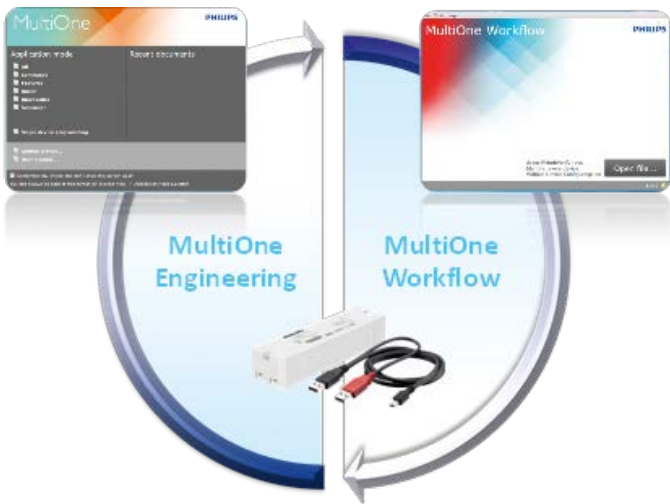

How to... Program the output current

1 interface – connecting to indoor & outdoor, LED & conventional

The Xitanium TD drivers offer a full range of controls, enabling customizable luminaire design and performance. It is possible to control light output levels, preset dimming protocols and set system specifications in the factory and even in the complete installations in the field. This can be done with the Philips MultiOne configurator software. The MultiOne configurator software is an intuitive tool that unlocks the full potential of all programmable drivers from Philips, ensuring that the driver performance matches the needs of the lighting solution. It offers unprecedented flexibility, before, during and after the product installation. With the latest selected drivers, SimpleSet functionality is also supported via MultiOne.

Please check the datasheet of the driver on www.philips.com/technology to know if your driver supports SimpleSet or not.”

Connecting to a programmable driver

Xitanium Indoor Linear LED drivers are programmed via the Philips MultiOne configurator software. To do so, the driver must be connected to the computer via the MultiOne hardware interface.

For more information and latest version please visit www.philips.com/multione.

This site contains detailed information on how to install the software and how to program the driver.

Mains voltage fluctuations and behavior

The driver is able to withstand high and low mains voltages for limited periods of time. See the associated datasheets for specific values.

Mains fluctuations

Professional luminaires using Xitanium or CertaDrive LED drivers make sure that a fluctuating mains is not transferred to the LEDs. It is the Power-Factor-Corrector stage that makes sure the luminaire draws a sinusoidal mains current in phase with the voltage. Mains variations are compensated and voltage spikes are damped, therefore have no effect on the light output.

Allowable voltage difference between mains input and control input (TD version)

The majority of our LED-drivers do comply with a voltage isolation difference up to 250V between mains and the Touch and Dim control input, as can be caused by a different phase of the power grid in an installation in the field.

Future drivers might have a value higher than 250 V by design.

Low mains voltage

A continuous low AC voltage (<202 V) can have an adverse effect on the driver's lifetime. The output power will be limited accordingly. A low voltage will not cause the driver to fail over a maximum period of 48 hours at minimum operating AC voltage and maximum ballast ambient temperature.

High mains voltage

A high mains AC voltage will stress the driver and have an adverse effect on its lifetime (maximum of 264-320 V for a period of 48 hours).

DC, DCemDIM and Emergency operation

The Xitanium Indoor Linear LED drivers are able to operate on DC voltage on the mains input, like when connected to a central DC emergency grid.

Depending on the type, Xitanium LED drivers are released in compliance with lamp control gear standards as stated under "Emergency standards" in section "Quality" at the end of this document. As a result these drivers are suitable for emergency luminaires in compliance with IEC 60598-2-22, excluding high-risk task areas.

Please note in the section Safety Precautions under Warnings the note on DC operation.

Please note the allowed DC voltage range accepted by the driver is stated in the driver's datasheet. Values outside that range will have an adverse effect on the driver's performance and possibly reliability.

On selected drivers DCemDIM is available, allowing a

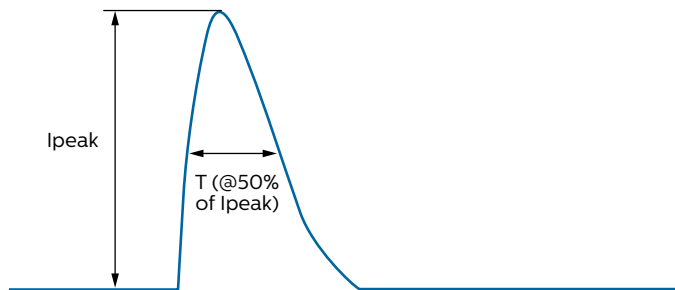

Graphical representation of inrush current

pre-defined dim level of the driver's output when switched to DC. More on setting parameters of DCEM DIM in section Controllability. For specific input requirements, please check the driver's datasheet at the download section on www.philips.com/technology.

Inrush current

'Inrush current' refers to the briefly occurring high input current which flows into the driver during the moment of connection to mains; see the illustration on the left. Typically, the amplitude is much greater than the steady-state input current.

The cumulative inrush current of a, given, combined number of drivers may cause Mains Circuit Breakers (MCB) to trip. In such a case, either one or a combination of the following measures need to be taken to prevent nuisance tripping:

- 1: Replace existing MCB for a less sensitive type (e.g. exchange B type for C type)
- 2: Distribute the group of drivers over multiple MCB groups or phases
- 3: Power up drivers sequentially instead of simultaneously
- 4: Install external inrush-current limiting devices

Inrush parameters are driver-specific and can be found in the driver datasheet at www.philips.com/technology.

How to... Determine the number of drivers on a MCB

The maximum amount of drivers on a 16A type B Miniature Circuit Breaker (MCB) is stated in the driver's datasheet on www.philips.com/technology.

In the conversion table on the left that stated amount is used as reference (100%).

The maximum quantity of drivers on different types of MCB can be calculated by the reference (see driver's datasheet) x Relative number (last column).

Example;

If datasheet states: max number on type B, 16 A = 20, then for type C, 13 A the value will be 20 x 135% = 27.

MCB type	Rating (A)	Relative number of LED drivers
B	10	63
B	13	81
B	16	100 (stated in datasheet)
B	20	125
B	25	156
C	10	104
C	13	135
C	16	170
C	20	208
C	25	260
L, I	16	108
L, I	10	65
G, U, II	16	212
G, U, II	10	127
K, III	16	254
K, III	10	154

Notes

1. Data is based on a mains supply with an impedance of 400 mΩ (equal to 15 m of 2.5 mm² cable and another 20 m to the middle of the power distribution) in the worst-case scenario. With an impedance of 800 m²Ω the number of drivers can be increased by 10%.
2. Measurements will be verified in real installations; data is therefore subject to change.
3. In some cases the maximum number of drivers is not determined by the MCB but by the maximum electrical load of the installation.
4. Note that the maximum number of drivers is given when these are all switched on at the same time, e.g. by a wall switch.
5. Measurements were carried out on a single-pole MCB. For multiple MCBs it is advisable to reduce the number of drivers by 20%.
6. The maximum number of drivers that can be connected to one 30 mA Residential Current Detector is 30.

Note: DM stands for Differential Mode, CM for Common Mode.

Surge protection

The Xitanium Linear drivers have built-in surge protection up to a certain limit. Depending on the mains connected, additional protection against excessive high surge voltages may be required by adding a Surge Protection Device. The actual limit can differ per driver and can be found in the driver's datasheet in the download section on www.philips.com/technology.

Note for Xtreme indoor drivers (iXt)

Xtreme Indoor Linear LED drivers (iXt) allow a higher maximum surge on the mains input (2 kV DM / 4 kV CM) than on the control input (1 kV DM / 2 kV CM), also stated in the driver's datasheet. As such Touch and Dim operation in environments with surges higher than 1 kV DM / 2 kV CM are not recommended.

Touch current

The Xitanium Indoor Linear LED drivers are designed to meet touch current requirements per IEC 61347-1 standard. The specified maximum values are 0.7 mA peak down to 0.4 mA peak for IEC and 0.75 mA RMS for UL norms. The test is done with the driver alone. In a luminaire, touch current may be higher, since the LED load may introduce additional touch current. As such, precautions may be required on the luminaire level and if multiple drivers are used in a single luminaire.

Note: check the driver datasheet of the driver you use for the specific touch current value and conditions

Tips on Total Harmonic Distortion (THD)

- THD is related to disturbance in the supply current a product is taking from the mains.
- This disturbance is caused by Harmonic currents (multiples of the master (mains) frequency).
- The THD together with the cos phi is decreasing the PF of a product.
- These harmonic current can affect electrical installation and power consumption.
- All uneven multiples of 3 times 50 Hz (third harmonic) can lead to overheating component in the electrical installation and un-intendent tripping of circuit breakers or blowing fuses.
- All harmonic currents are leading to extra losses in the electrical installation and so to a higher power consumption.
- For all products complying to the standard, EN 61000-2-3, the above stated affect are of minor importance.
- Products compliant with EN 61000-2-3, will not cause overheating or tripping of circuit breakers in correct designed installations.
- In case of a PF of 0.9 the extra losses in the electrical installation is 0.5 up to 1% of the load.
- In case of a PF of 0.8 the extra losses in the electrical installation is 1 up to 2.5% of the load.
- Only part of the PF is related to THD.
- THD of 20% in most cases is creating a PF of more than 0.8.
- A THD of 20% is still not causing overheating in electrical installations.
- In case of dimming, some harmonics can increase, however, the overall load on the electrical installation and the losses are decreasing.

Electromagnetic compatibility (EMC)

Xitanium Indoor Linear LED drivers meet EMC requirements per CISPR 15 ed 7.2. The test is conducted with a reference setup that includes a driver and an LED load mounted on a metal plate.

Cable length and EMC

Philips has successfully performed EMC tests for a total length 4 m (sum of wire length and length of the Fortimo LED Line boards). The only limitation of wiring length is the EMC performance. Since this performance of the luminaire is heavily dependent on the wiring itself we advise for longer lengths to repeat these tests.

How to... Improve EMI performance

As mentioned before, the total amount of parasitic current needs to be minimized. For that reason, the following practical precautions need to be taken into account in a lighting system to minimize EMI:

- Minimize the Differential Mode loop area of the lamp wires going from the driver to the light source by keeping the wires close together (bundling). This will minimize the magnetic field and reduce the radiated EMI. Long linear light sources are also part of that loop.
- Minimize the Common Mode parasitic capacitance of the output wiring + light source to earth by keeping the length of the wires between driver and light source as short as possible. Also minimize the copper cooling area on the LED PCB and keep the length of the incoming mains wire inside the luminaire as short as possible.
- Keep mains and control wires (DALI, 0-10 V) separated from the output wires (do not bundle).
- Ground the lighting system chassis and other internal metal parts to earth (class I luminaires) and do not let large metal parts “float”. Always use the safety or functional earth connector or wire from the lamp driver. Or use equipotential connecting wires for all internal floating metal parts which are inaccessible (class II luminaires). Keep safety and functional earth wires as short as possible to minimize their inductance, use as much as possible large metal areas (chassis, mounting plates, brackets) for earthing purposes instead.
- For Class II it is advised to establish a functional earth connection between all larger conductive, non-accessible luminaire parts and the driver to remedy potential EMC problems.
- Sometimes, radiated EMC compliance cannot be achieved, necessitating the use of a 100 ... 300 Ω axial ferrite bead(s) for either mains or lamp wiring (effective for interference between 30 MHz and 300 MHz), or coupling the wires through ferrite cores within the luminaire may improve the overall EMC performance. However, selection of the type and characteristics of the additional filter depends on what frequency components have to be damped and by how much.

Adhering to these rules will help in EMC compliance. For further questions, please contact your local Philips representative. Alternatively the Philips Lighting OEM Design-In team could be consulted for a possible solution.

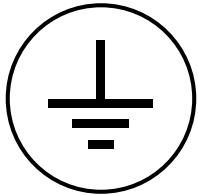

Symbol for Protective Earth (PE)



Example of an insulated Rset



Warnings for non-isolated drivers:

- Do not touch any non-insulated live parts, even on the output (secondary) side!
- Any live part on the output (secondary) side should not be touchable during normal operation. This includes the NTC component and Rset component.
- Make sure to insulate the Rset to prevent it from touching the housing.

Electrical isolation and protective earth

One way to split the Xitanium Indoor Linear LED drivers is by isolated and non-isolated driver versions.

Non-isolated drivers

These drivers have no isolation from the primary to the secondary side and basic isolation (single isolation foil) between all the electronic circuits and the chassis, hence the presence of the Protective Earth (PE) symbol (see image on the left) on the driver housing.

Non-isolated drivers can be used in Class I luminaires. Be aware that all output connections of these drivers are not touch-safe when the driver is switched on. An adequate earth connection needs to be made to all electrical conductive parts in the luminaire. The bottom part (unpainted) of the driver housing can be used to create earth contact to the luminaire housing, as the earth connector is internally connected to the driver housing. An intermitting earth contact should be prevented, as this is potentially unsafe and can cause a degraded performance. Most drivers in this group typically can generate output drive voltages higher than 60VDC. Always test the quality of your earth contacts between all relevant conductive parts.

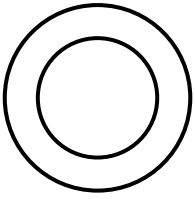

Symbol for Double Isolation between primary and secondary side of a driver, in combination with built-in usage.

Isolated drivers (SELV output)

Drivers in this group cannot generate output voltages higher than 60 VDC. By design these drivers are intended for built-in use, not suited for independent use. The driver must be placed in a suitable adequate enclosure according to the applicable norms and standards. Hence the double circle symbol is to be used, not the double-square symbol (Amendment 2 of safety standard IEC61347-1).

However, these isolated drivers (SELV output) can be used in both Class I and Class II luminaires under the following conditions:

- When used for **Class I** the protective earth connection should be present (see previous section “Non-isolated drivers”).
- When used for **Class II** (and **SELV**), the driver should be incorporated in the luminaire in such a way that
 - a) The driver housing is electrically insulated with respect to electrical conductive materials, such as the housing or reflector and as such not touchable during installation or operation.
 - b) All metal luminaire parts (chassis, heat sink, metallic reflector) connected to the driver housing are not allowed to be accessible by bare hand, or
 - c) Any accessible conductive luminaire parts should have basic isolation towards the non-accessible luminaire parts and/or driver housing.

Note: for Class II, EMC requirements should be met without PE connection and particularly also any functional earth connection from driver to accessible fixture/chassis is strictly prohibited, as it will form insufficient (non-single fault-proof) insulation with respect to live parts connected to the driver.

Xitanium Indoor Linear LED drivers meet the IEC 61347-1 safety standard

In accordance to this standard, the following safety requirements are met:

- Basic isolation between the Primary and Secondary side wires:
- Driver output voltage < 1000 VDC
- Insulation test voltage 1500 V (1000 V + 2 X 250 V)
- Double isolation between all wires and chassis:
Insulation test voltage: 3750 V.

How to... Use these Indoor Linear LED drivers as “independent” driver

By design the Xitanium Indoor Linear LED drivers are intended for built-in use, not suited for independent use. The driver must be placed in a suitable adequate enclosure according to the applicable norms and standards when used independently.

Thermal design-in

Introduction

This chapter describes two thermal aspects of the Xitanium Indoor Linear LED drivers:

1. The LED driver itself and relationship between case temperature point (T_c) and lifetime of the LED driver
2. Module Temperature Protection (MTP) can be used to help achieve lifetime of LED module or LED PCB.

To facilitate design-in of LED drivers, the critical thermal management points of the LED driver are set out in this section. In Philips' product design phase all possible precautions have been taken to keep the component temperature as low as possible. However, the design of the luminaire and the ability to guide the heat out of the luminaire are of utmost importance. If these thermal points are taken into account this will ensure the optimum performance and lifetime of the system.

Definitions

- Case temperature: temperature measured at the T_c point of the driver
- Ambient temperature (T_{amb}): temperature outside the luminaire

When switched off >2 hours, temperature at T_c point is likely to equal T_{amb}

T_c point

To achieve optimal lifetime and reliability, it is critical that the temperature of the components in the driver remains within its rating.

The T_c test point (case temperature) indicates a reference point for measuring the LED driver's temperature. This can be used during the luminaire design to verify that the temperature remains below the maximum specified temperature for the T_c point.

Since there is a direct relation between the case temperature (T_c) and the driver components inside the driver, it is sufficient to measure the temperature at the T_c point of the LED driver. This T_c point must not exceed the maximum values stated in the associated datasheet in the download section on www.philips.com/technology.

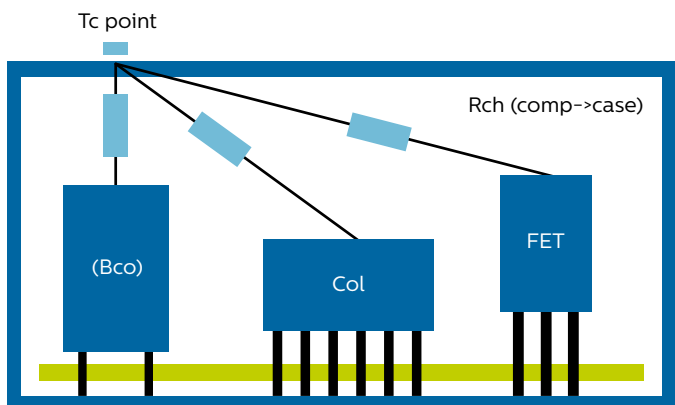

Schematically representation of internal thermal paths to the driver T_c point

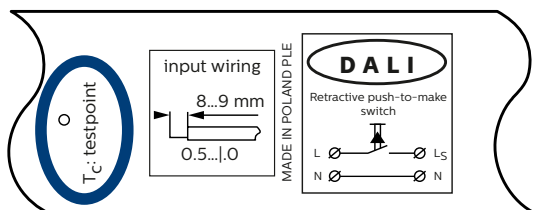

Example of T_c point position on driver housing

How to... Measure Tc at the Tc point

The location of the Tc point is identified on the product label. Tc point is inside the dot (See ellipse in figure on the left). The temperature can be measured using for example a thermocouple that is firmly glued to the driver housing. For a representative measurement the temperature must be stable before any reliable data can be obtained (typically > 0.5 hours).

Relation between Tc and ambient temperature

The Tc increases by approximation linear with the ambient temperature (Tamb). The temperature offset between Tamb and Tc depends on the thermal design of the luminaire. The Xitanium LED driver has been designed for indoor use. For approved ambient temperature range please check the associated driver datasheet on www.philips.com/technology.

Driver lifetime

Tc, Tc-life and Tc-max

The lifetime of LED drivers depends on the temperature during operation. This means there is a relationship between the Tc point on the LED driver and its lifetime in hours.

- Xitanium Indoor Linear LED drivers typically have a specified minimum lifetime of $\geq 100,000$ hours with a minimum of 90% survivors at the specified Tc max-10°C.
- Xitanium Indoor Linear Xtreme LED drivers typically (iXt) have a specified minimum lifetime of $\geq 100,000$ hours with a minimum of 90% survivors at the specified Tc-life.

Tc-max is the maximum allowed Tc for the driver. Please check the driver's datasheet in the download section on www.philips.com/technology for the lifetime and Tc-life.

Module Temperature Protection (MTP)

NTC and thermal design

This feature helps to protect the LEDs when operated in a hot ambient environment. The thermal design of an LED module/PCB should be designed in such a way that the temperature of the LED board (Tc-life) is not exceeded under normal application conditions. The utilization of a Negative Temperature Coefficient (NTC) component serves the purpose to help achieve the lifetime of the LED module or LED PCB if external thermal influences result in the temperature for lifetime (Tlife) being exceeded. When this occurs the light output will be regulated to remain below the critical temperature by the driver dimming down.

Two NTC part numbers which are supported, while the third option enables correct operation in combination with Philips LED modules.

1. 15 k NTC - Vishay 15 kOhm \pm 2% NTC, B25/85=3700, 2381 615 54153
2. 15 k NTC - Murata 15 k, Part number NCP15XW153E03RC (with a Separate 390 ohms resistor in series with the NTC)
3. On selected Philips LED light engines (currently no LED Lines)

Setting the thermal de-rating point via NTC

The LED driver will start reducing the light output when the NTC reaches a value of 2966 Ω . The NTC should be selected such that 2966 Ω represents the desired critical temperature inside your LED module/PCB.

Take for example an LED board with a defined Tc-life of 65 $^{\circ}\text{C}$. Taking the tolerances of the NTC into account results in ± 5 $^{\circ}\text{C}$. This gives a typical value for the NTC of 71 ± 5 $^{\circ}\text{C}$. By choosing this setting of 71 $^{\circ}\text{C}$, we ensure that the driver will not dim the output, due to a too high temperature, before the module reaches 65 $^{\circ}\text{C}$. The following graph shows a typical R vs. T curve of an NTC resistor. To match 2966 Ω at this temperature, the NTC of 15 k Ω $\pm 2\%$ has been selected.

Setting MTP behavior (programmable drivers only)

It is possible to set the temperature at which MTP feature is activated, defined by "MTP warn" and the slope, defined by "MTP max". Using the MultiOne Configurator software the settings can be changed.

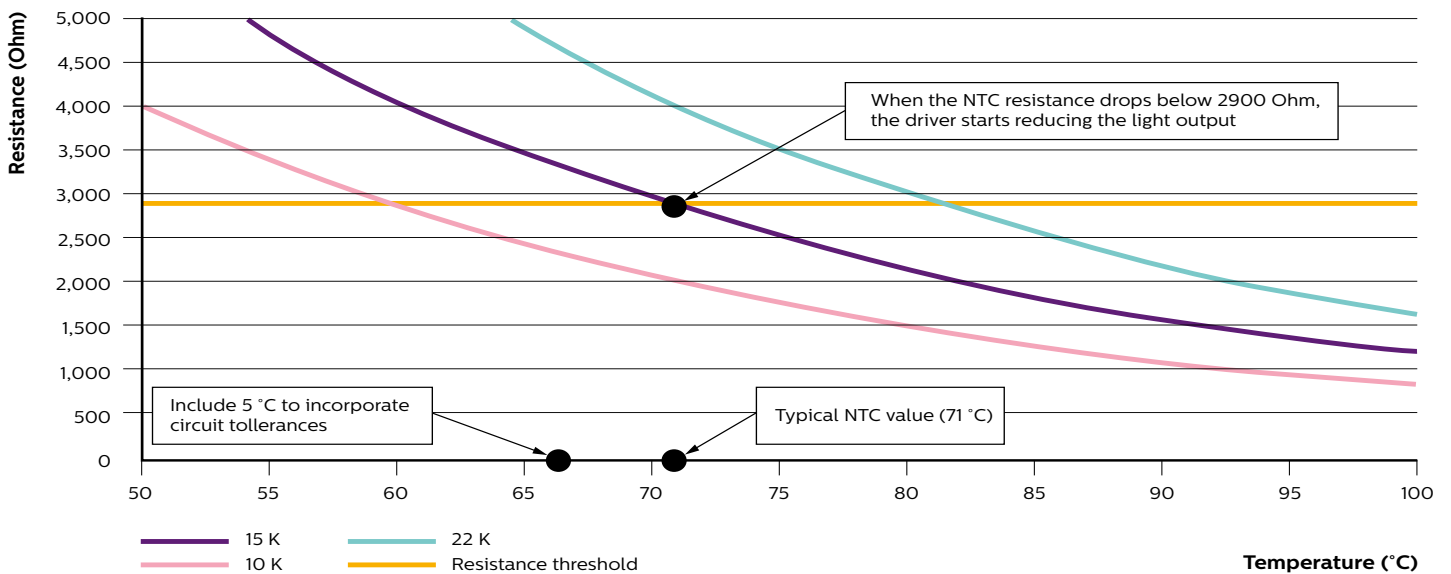

NTC resistance as function of temperature

Controllability

Control characteristics

Amplitude Modulation dimming

Philips Xitanium indoor linear LED drivers dim by means of Amplitude Modulation dimming (AM). This means at no stage of the dimming range Pulse Width Modulation dimming (PWM) is involved. AM dimming guarantees the most smooth and flicker-free operation over the entire dimming range.

Dimming ranges

In the current portfolio there are three different dimming ranges present.

- 100% down to 10%
(e.g. 1-10 V non-isolated drivers with introduction date before 2015)
- 100% down to 5%
(e.g. isolated drivers with introduction date before 2014)
- 100% down to 1%
(latest generations dimmable drivers)

The driver's actual dimming range is stated in the associated datasheet on www.philips.com/technology. With future updates of the drivers most likely one dimming range will be present.

Note: for Xtreme Indoor Linear LED drivers (iXt) the allowed dimming range is dependent on ambient temperature (T_{amb}). The influence of the ambient temperature on the minimum allowed dimming levels are stated in the table below. The applicable minimum dimming value should be set via the MultiOne configurator software, The default value is stated in the driver datasheet.

$T_{amb} -40..-25\text{ }^{\circ}\text{C}$	$T_{amb} -25..+50\text{ }^{\circ}\text{C}$	$T_{amb} +50..+60\text{ }^{\circ}\text{C}$
Minimum dimming 10%	Minimum dimming 1%	Minimum dimming 10%

Minimum dimmed output current

The drivers' min-max current range is by approximation a factor of 140. This means that a 1% minimum dimming current is not feasible for the full operating window. For the lower current part of the operating window the dimming level is limited by an absolute minimum output current of the driver (see drawing). This value differs per LED driver by design. Some examples are provided in the table on the left.

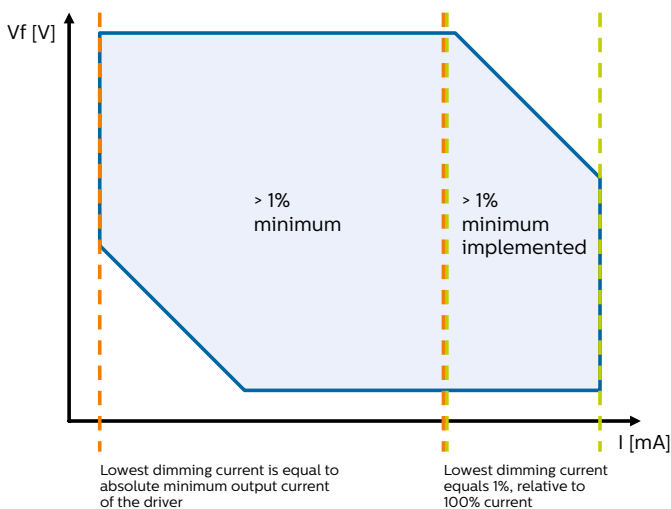

Minimum dimming output current

Maximum selectable output current [mA]	Minimum absolute output current [mA]	Current range allowing for 1% dimming [mA]	Drivers examples
400	3	300..400	Xitanium 75W 0.12-0.4A 215V TD 230V
700	4	400..700	Xitanium 150W 0.2-0.7A 300V TD 230V iXt
2000	14	1400..2000	Xitanium 75W 0.7-2A 54V TD 230V

Dynamic resistance of the LED load

The Xitanium drivers are designed to drive and dim LED loads with a specified minimum dynamic resistance of the load, stated in the driver's datasheet. This has been tested and released with the Philips Fortimo LED modules. LED loads which have a dynamic resistance outside the specification of the driver may cause instabilities and should not be used in combination with this driver.

When light instabilities and/or uniformity issues are observed during deep dimming (e.g. down to 1%) it is recommended to increase the minimum dim level by adjusting the DALI minimum dim level to the point the effects are no longer perceived. The required minimum dynamic resistance is stated in the drivers' datasheet.

1-10 V Dimming

This is the traditional way of dimming a driver between 100% and 10% based on dimming voltage, in 1% increments. Note that the 100% level is determined by the output current level, set via external Rset (AOC feature). The minimum current that can be supplied by the driver is specified in the datasheet. The lowest possible dim level is defined by the higher of the two values: Minimum output current or 10% dim level. Output current of the 1-10 V control input is typical 150 μ A. The 1-10 V interface for LED-drivers is the same as for FLUO HFR drivers.

TD dimming: Touch and Dim & DALI

DALI

Digital Addressable Lighting Interface, or DALI, is a bi-directional digital communication protocol popular in the lighting industry. It is an IEC standard and there are many control devices from Philips and other manufacturers that communicate using DALI. The voltage across DALI wires is typically 16 V (refer IEC specification for details) and it is not polarity sensitive. The DALI wires can be run alongside input main wires and the maximum current on a DALI line is limited to 250 mA.

Using DALI, it is possible to send dimming commands (1-254 levels), set fade rates and fade times, query driver or LED status, etc. Linear drivers also respond to LED-specific DALI commands e.g. query if the LED module is short circuit or open circuit; select between logarithmic or linear dimming curves, etc. Typically up to 64 DALI drivers can be connected to one DALI bus. Note that after a power cycle (not standby) the driver by default will come back to its

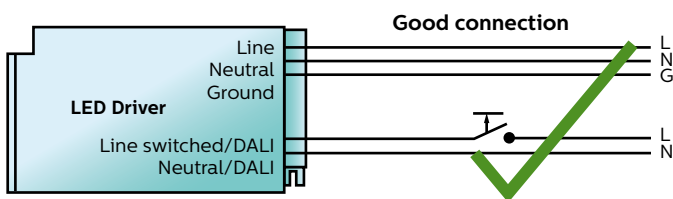
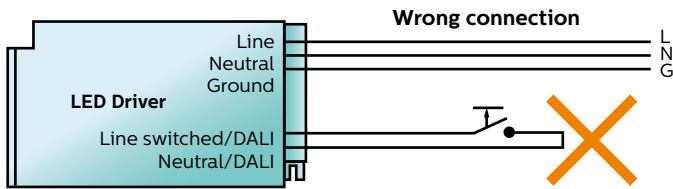

Appropriate connection to the dimmable LED driver using the Touch and Dim protocol

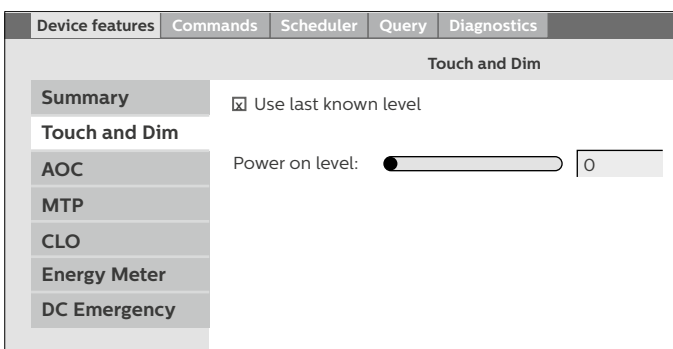

Screenshot from MultiOne – Touch and Dim tab

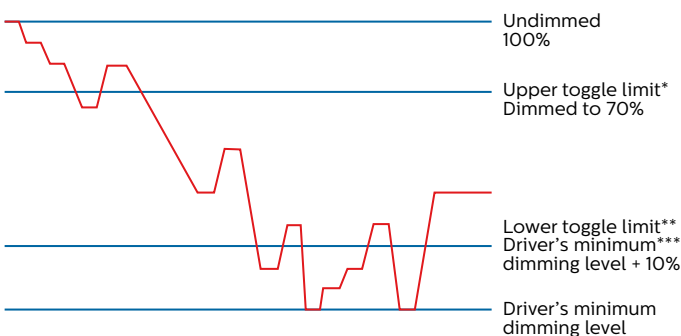

* Always dim down above the upper toggle limit
 ** Always dim up under the lower toggle limit
 *** Example, a driver with dimming minimum of 10% leads to lower toggle level of 10% + 10% = 20%
 1% leads to lower toggle level of 10% + 1% = 11%”

Touch and Dim function	Contact duration	Driver function
Ignore	0 to 40 ms	Ignore
Short push	40 to 500 ms	Toggle ON/OFF
Long push	500 to 10,000 ms	Dim up or down
Reset push	>10,000 ms	Driver synchronization

last known light level. This behavior however can be programmed differently into “off” or any dim level between 1..254 DALI level.

For more information on DALI, refer to the IEC specification for DALI protocol.

- IEC 62386: 102 – General requirements – Control gear
- IEC 62386: 207 – Particular requirements for control gear – LED modules.

Touch and Dim

For the Xitanium drivers with Touch and Dim function a switched mains is used to dim the light. The switching ON and OFF is also done via this control input. This means that it is no longer necessary to use a power switch to interrupt the mains circuit. The 230 V supply voltage is always available at the LED driver (even when switched OFF) and light can be switched or dimmed by momentarily connecting the mains to the dim input. A short push will switch the lighting ON or OFF, depending on the previous situation.

Touch and Dim behavior

If via TD control the driver is switched OFF (short push), the ballast will store the current light level. As soon as the mains power returns (short push via TD will switch the driver ON) the ballast will recall this stored light level. If it was dimmed to 60%, it will come back at 60%.

If the switch is held pushed in, the light will dim up or down, depending on what is opposite from the last dimming direction. The driver will count the number of mains cycles and act on that.

If there is a power failure, the ballast will store the current light level. As soon as the mains power returns, the ballast will recall this stored light level. If it was dimmed to 38%, it will come back at 38%. If it was switched off, it will stay switched off. This behavior can be altered via MultiOne configurator software (screenshot on the left).

If the installation has to be extended by one or more light points / drivers, the dimming direction of the newly connected modules may be different from that of those already connected. To solve this problem a synchronization possibility is built into the drivers and can be called upon at any time. If the switch is pressed for at least 10 seconds all drivers will go to 37% light level and the dimming direction will be set to downwards.



Note

The TD connection has to be on the same phase as the mains connected to the driver.
See also section Allowable voltage difference between mains input and control input (TD version)

Touch and Dim wiring

Special wiring, such as twisted pairs or special cables, is not required to install a Touch and Dim system. All wiring is standard mains wiring and the switch is a standard push-to-make switch. There is no limit to the length of the dim cable or the number of switches connected. The only limitation is the maximum amount of drivers, which is 30 per dimming unit.

Non-dimmable

The current of the non-dimmable Xitanium drivers can be set with Rset within the operating window. During normal operation, the set current cannot be changed.

Application guidelines

RC filter for Touch and Dim interface. When a Touch and Dim interface is used that works with the mains voltage (Touch and Dim can work with several different voltage levels) and in combination with long cable lengths, high voltage spikes might occur. These voltage spikes can have a negative effect on the performance of the older generation Xitanium Indoor Linear TD LED drivers (listed in table below). To prevent this from happening Philips strongly advises to add a simple RC filter in the system for every Touch and Dim interface that is used, comprising a positive temperature coefficient thermistor. It is advised to install the RC filter directly after the Touch and Dim switch. TD drivers not listed are not advised to make use of this filter.

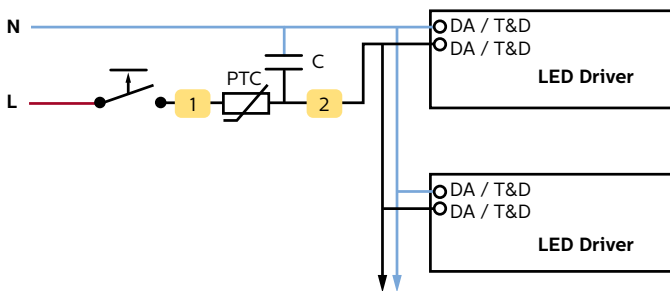

Schematic of Touch and Dim behaviour

The diagram on the left shows a Touch and Dim controlled system with the RC-filter added. The RC filter consists of following components:

- PTC Resistor R = 80-150 Ohm Max Voltage Rating > 250 V
- Capacitor C = 330 nF Type X2 275 V

Listed drivers are strongly advised to use the RC filter when operated via Touch and Dim

Driver descriptive name	12nc
Xitanium 17W/0.12-0.4A 54V TD 230V	9290 006 84703
Xitanium 36W 0.12-0.4A 100V TD 230V	9290 006 73703
Xitanium 75W 0.15-0.4A 200V TD 230V	9290 006 70403
Xitanium 75W 0.2-0.4A 200V TD 230V	9290 006 17303
Xitanium 75W 0.7-2A 54V TD 230V	9290 006 92103
Xitanium 75W 2A 54V TD/TE 120-277V	9290 006 36913
Xitanium 75W/160mA 200V TD 230V	9290 008 15903
Xitanium 75W/200mA 200V TD 230V	9290 006 61803
Xitanium 75W/240mA 200V TD 230V	9290 006 61903
Xitanium 75W/280mA 200V TD 230V	9290 006 62003
Xitanium 75W/320mA 200V TD 230V	9290 006 62103
Xitanium 75W/360mA 200V TD 230V	9290 006 62203



Example of a shorted DALI interface

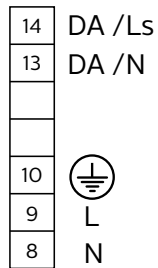

Note: the TD connection has to be on the same phase as the mains connected to the driver. See also section Allowable voltage difference between mains input and control input (TD version)

TD as non-dimmable

When a TD driver is used without any controls connected to the control input, it operates as a non-dimmable driver. However, fluctuations on the power line or other similar interferences might trigger a Touch and Dim lamp OFF command. Due to the fact that no control interface is connected, the system cannot be switched on again. To prevent this, Philips strongly recommends to shortcut the DALI control interface. The DALI interface is also used for connecting the Touch and Dim controls and, by shortcutting this interface, accidental triggering of OFF commands is prevented. DALI shortcutting is required for the following drivers:

Driver descriptive name	12nc
Xitanium 17W/0.12-0.4A 54V TD 230V	9290 006 84703
Xitanium 36W 0.12-0.4A 100V TD 230V	9290 006 73703
Xitanium 75W 0.15-0.4A 200V TD 230V	9290 006 70403
Xitanium 75W 0.2-0.4A 200V TD 230V	9290 006 17303
Xitanium 75W 0.7-2A 54V TD 230V	9290 006 92103
Xitanium 75W 2A 54V TD/TE 120-277V	9290 006 36913
Xitanium 75W/160mA 200V TD 230V	9290 008 15903
Xitanium 75W/200mA 200V TD 230V	9290 006 61803
Xitanium 75W/240mA 200V TD 230V	9290 006 61903
Xitanium 75W/280mA 200V TD 230V	9290 006 62003
Xitanium 75W/320mA 200V TD 230V	9290 006 62103
Xitanium 75W/360mA 200V TD 230V	9290 006 62203

For all other drivers, this is not necessary.

Open control wires

If control cables outside the luminaire are already connected to the control input of the LED-driver but are not yet in use, it is advised to short-circuit these cables.

Configurability



Philips MultiOne USB2DALI hardware interface



Example of a MultiOne SimpleSet interface

Connecting to a programmable driver

Xitanium Indoor Linear LED drivers are programmed via the Philips MultiOne configurator software. To do so, the driver must be connected to the computer via a hardware configurator interface.

This configurator consists of:

1. Philips MultiOne Interface tool
2. USB cable (connection to PC or laptop)
3. Philips MultiOne Software™

Please check the datasheet of the driver on www.philips.com/technology to know if your driver supports configurability.

For the latest version of the MultiOne configurator software please check www.philips.com/multione.

Philips MultiOne Interface tool

There are 2 versions of MultiOne interface tooling depending on the type of communication:

1. LCN8600/00 MultiOne Interface USB2DALI

The interface that can be used with the MultiOne PC software to commission, configure, diagnose drivers via the DALI interface

2. LCN9600 MultiOne SimpleSet interface

The interface that can be used with the MultiOne PC software to configure drivers wirelessly using SimpleSet technology.

Note: The programming of the drivers with SimpleSet must be done while disconnected from mains.

Make sure the programming tool is able to touch to blue SimpleSet(R) antenna. A sheet of metal between the programmer and antenna will disable programming. When ordering the MultiOne Interface, the correct USB cable will be supplied with the interface tool.

The tool can be ordered via your Philips sales representative or via the Philips OEM webshop, oemwebshop.philips.com.

When powering up the driver (after programming via SimpleSet) apply the specified mains voltages for at least 1 second.

If the applied mains voltage is below the specified minimum value and the duration is less than 1 second it is possible that the new setting is not programmed into the driver's EEPROM.

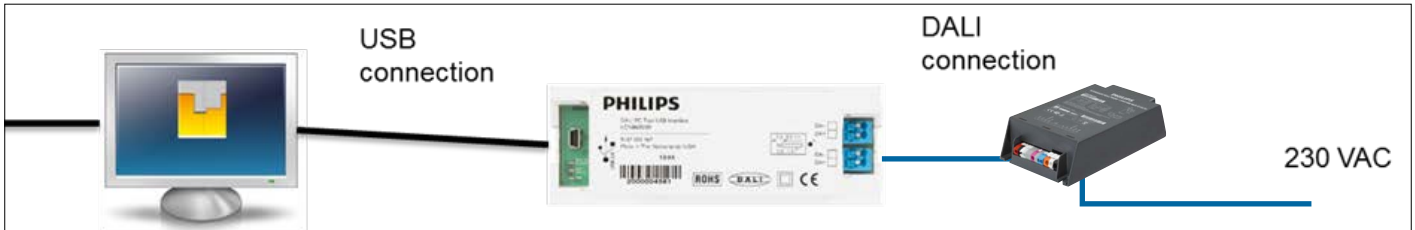

Settings

The Xitanium configurable LED drivers have a fixed set of features and factory settings when supplied. The set of features is defined in the datasheet of the driver. The default settings of the driver can be found in the driver's datasheet in the download section on www.philips.com/technology

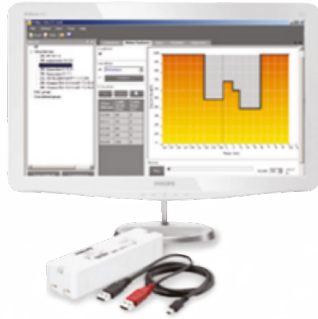

Example of a shorted DALI interface

Philips MultiOne Software

There are 2 versions of MultiOne Software depending on functionality and location:

1. MultiOne Engineering

Especially developed to access all functionality of the driver; to configure, diagnose and prepare the configuration file for the production environment.

Includes also:

- DALI commands, scheduler.
- SimpleSet.

2. MultiOne Workflow

Developed to configure all devices or subassemblies in the production environment or field in a simple and quick way.

Get your software (free downloadable) or check if you have the latest version via the website, www.philips.com/multione.

Getting Started

Connect the USB cable of the MultiOne Configurator between the PC and the configuration tool.

To install the software, launch the installation file for the latest version and follow the instructions on your screen. The installation wizard will guide through the process of installing the software and will ask where the software needs to be installed, if a shortcut is needed on the desktop and a new program is also created in the Start Menu.

More information on how to program a driver, can be found in getting started and the instruction manual on the website, www.philips.com/multione.

How to... See the programming taking effect

Programming time

Depending on the selected features to program, the programming time varies between 2 up to about 15 seconds. It is possible to program up to 64 drivers at the same time. In case of group programming there is no individual confirmation (verification) from each driver.

In order to have the programmed values take effect for Xitanium Indoor Linear LED drivers, the mains power needs to be cycled. For newer drivers (1% minimum dim level) On/Off via standby is also sufficient.

Note on Corridor Mode: after a power cycle (e.g. reconnection after luminaire installation) the Corridor Mode needs to be reactivated via the activation pulse. See also upcoming section on Corridor Mode.

Module Temperature Protection (MTP) behavior setting

For an extensive explanation of all functionality and allowed values, please refer to the MultiOne configurator software manual, to be found on www.philips.com/multione.

Note: once MTP is enable the LEDset functionality using an Rset (resistor component) is no longer possible. AOC can be done by either DALI or SimpleSet programming, depending on the driver's features.

Depending on module temperature, the driver current will follow the linear line between 100% and "R stop dim" (default 10%). At the rated operating conditions of the luminaire, the LED module temperature should not exceed "R start dim" by design. The MTP feature is helpful in maintaining LED life during occasional/temporary heat spikes like a hot day or loss of air conditioning. The driver responds dynamically to changes in parameters of MTP. There is no need to reset the driver for changes in these parameters to take effect.

Values for R and Beta specify the characteristics of the NTC on the LED modules

	R	Beta
Vishay 15 kΩ	3,700 (default in MultiOne)	15,000 (default in MultiOne)
NTC 10 kΩ	3,850	10,000
Murata 15 kΩ	15,000	3,987
LED light engines	3,700 (default in MultiOne)	15,000 (default in MultiOne)

MTP via a LEDset input

Three clusters have been defined for Xitanium window drivers in order to create the required resolution

I.	100mA – 500mA	LEDset resistor range 50k – 10k
II.	300mA – 1000mA	LEDset resistor range 16.7k – 5k
III.	700mA – 2000mA	LEDset resistor range 7.1k – 2.5k

The values and ranges are listed in the tables on the left.

Symbol	Value	Temperature with recommended circuit	Remarks
R _{WARN}	27 kΩ	70 °C	NTC= NCP18WM474J03RB R _{par} = 47 k
R _{MAX}	22,5 kΩ	80 °C	
Derating Dimlevel	10%	-	Independent of driver minimum dim level

Default values for indoor drivers, Cluster I

Symbol	Value	Temperature with recommended circuit	Remarks
R _{WARN}	10 kΩ	70 °C	NTC= NCP18WM224J03RB R _{par} = 15 k
R _{MAX}	8,7 kΩ	80 °C	
Derating Dimlevel	10%	-	Independent of driver minimum dim level

Default values for indoor drivers, Cluster II

Symbol	Value	Temperature with recommended circuit	Remarks
R _{WARN}	4,7 kΩ	70 °C	NTC= NCP18WF104J03RB R _{par} = 6 k8
R _{MAX}	4,1 kΩ	80 °C	
Derating Dimlevel	10%	-	Independent of driver minimum dim level

Default values for indoor drivers, Cluster III

Constant Lumen Output setting and CLO 2.0

Traditional light sources like TL and HID typically suffer from depreciation in light output over time. This applies to LED light sources as well. The CLO feature enables LED solutions to deliver constant lumen output through the life of the light engine. Based on the type of LEDs used, heat sinking and driver current, it is possible to estimate the depreciation of light output for specific LEDs and this information can be entered into the driver. The driver counts the number of light source working hours and will increase output current based on this input to enable CLO.

Example with CLO

When the CLO feature is enabled (thick the box), the driver nominal output current will be defined by the CLO percentage as shown by the equation below:

$$\text{Driver target nominal output current} = \text{CLO [\%]} \times \text{AOC [mA]}$$

Assume a driver with a current range of 300–1000 mA. For example, in the CLO profile shown in figure on the left, between 20,000–30,000 working hours, the CLO percentage is set at 70%. Assuming the nominal AOC is set to 800 mA, the driver output current with CLO enabled will be $0.7 \times 800 = 560$ mA from 20 kh to 30 kh.

Please take into account what the AOC (driver current) needs to be when CLO reaches 100%. This value might be higher than the nominal current stated in the datasheet of the LED board. Since the CLO curve is not generic, the OEM needs to determine the appropriate CLO curve for a given luminaire. This can be used to differentiate on e.g. lumen output or power consumption over lifetime.

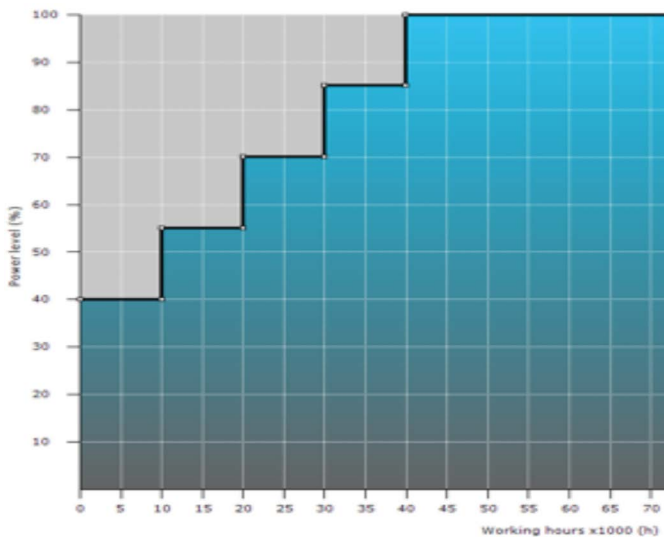

Configure Constant Light Output feature

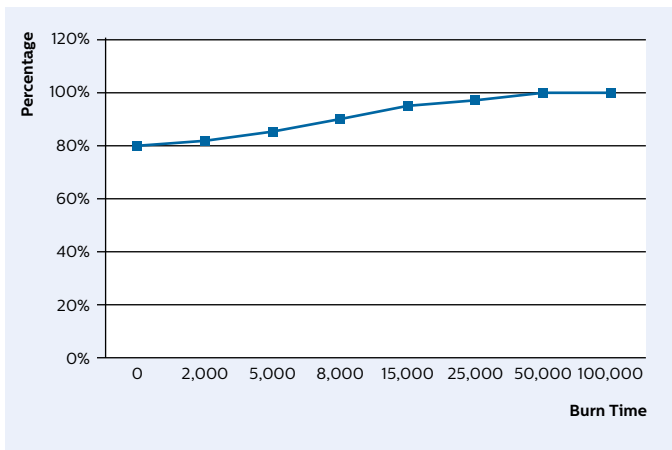

Example

AOC set to 200 mA, DCemDIM set to 15% (DALI value 185).
 Result when mains switched to DC is that the driver outputs
 $200 \text{ mA} \times 15\% = 30 \text{ mA}$.

For the driver's default settings please check
 the associated datasheet on www.philips.com/technology.

Example with CLO 2.0

The time variable is the time at which the driver switches to the current timeslot linear interpolation curve. The first timeslot should always be 0. The actual output limitation is calculated between two neighboring percentage set points on the current timeslot and next timeslot. So for example the first slot is [Percentage = 80, Time = 0], the second slot is [Percentage = 82, Time = 2]. This means that driver will start from 80% operation, and during first 2000 hours, the output limitation will be calculated as a linear curve from 80% to 82% based on the burning time. After 2000 hours are passed, it will then be operation at 82% and switch to the next linear curve calculated based on the percentage in 2nd slot and 3rd slot. Example graph on the left.

DCemDIM setting

During emergency situations often a 100% light level is not required so power load can be lowered and energy can be saved. DC emergency dimming function is intended to dim the light to a predefined light level as soon as DC mains is applied to the driver's mains input. The MultiOne configurator software can be used to configure the DC emergency dimming feature of the driver.

Corridor Mode setting

The Corridor Mode adjusts the light to a defined level when a presence sensor detects a person. Corridor Mode can only be activated when the device is in Touch and Dim mode. The settings can be customized to suit your application using the Philips MultiOne configurator software, after which it automatically is in the DALI mode.

Activate Corridor Mode

- a) Hardware by means of providing mains voltage to the control input for at least the “Activation time” (default 55 s).
- b) Set via MultiOne configurator software, cycle mains and activate

If the switch in the application cannot make a pulse that long, via Dali programming the parameter Activation Time in tab Corridor Mode can be adjusted according requirements. For example shortened to 10 s. This value is then stored and will be available after a power cycle.

Reactivate Corridor Mode after a mains power cycle

Please note, when the mains is cycled (e.g. after installation of the luminaire) default the Corridor Mode will be disabled (Touch and Dim will be enabled). This behavior is similar to the conventional Philips fluorescent ballasts. Once powered again the Corridor Mode needs to be reactivated (see previous section).

De-activate Corridor Mode

- a) Cycling the mains on both control input and mains input of driver.
- b) De-select via MultiOne configurator software, cycle mains. Activation via hardware (TD) is no longer possible, only via MultiOne software. The driver enters this mode with default settings.

Note: if available **Sensor delay time** is set on the sensor itself

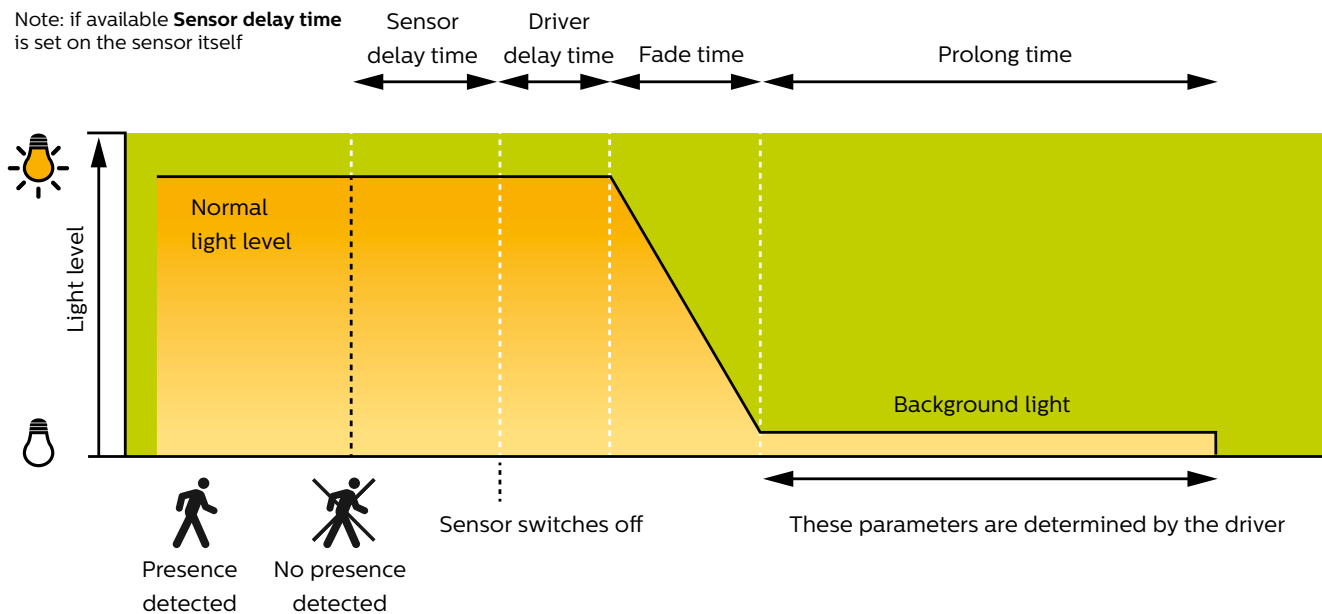

How to... Set the DALI minimum dimming level

A practical example when to do this; having a 1% dimming driver next to an older 10% dimming driver controlled in the same installation.

Quality and Reliability

Switching & cycling lifetime of LED drivers

Impact of on and off switching on lifetime of electronic drivers in LED systems

In this section a description is presented of the impact of mains voltage switching on the lifetime of electronic drivers in lighting systems. Because switching on and off the lighting has an impact on different failure modes, a distinction has to be made between switching on and off, and thermal cycling.

Electrical failures due to switching Vmains on and off

Before the lighting is switched on in the electronic circuit all capacitors are uncharged. By a simple toggle of the mains voltage all capacitors will be charged, causing peak currents in the circuit. Inductors react to this by creating peak voltages. Occurrence of peak currents & voltages during starting is inevitable. The circuit design and component selection should be of sufficient quality that no components are overstressed during the starting conditions. If the quality is not sufficient, failures will occur at a certain rate over time. The failure rate will be influenced by usage conditions such as temperature and mains voltage. The failure rate will be further enhanced by irregular mains voltage events such as dips, surges or black outs. For a good quality design all conditions and components are carefully checked. In general LED systems and products are designed to withstand >100,000 switches under the specified use conditions.

Mechanical failures due to thermal cycling

A completely different failure mode which is also due to switching on and off the light is the failure of solder joints, due to thermal cycling. Stresses in solder joints are caused by the differences of the thermal expansion coefficients (CTE's) of printed circuit board, solder and component materials.

Due to heating up and cooling down mechanical stresses build up in the solder, which eventually result in cracking and finally failure of the joint. In most cases failure of one solder joint means the end of the product. The solder joint failure mechanism is also referred to as solder joint fatigue. This is a typical wear out failure mechanism with a negligible failure rate for many years, but for which after the typical lifetime has passed, failures come at an accelerated speed.

Electronic Drivers for LED lighting are typically designed to last 50,000 operational hours. The reference for this lifetime is a typical user profile of 10-12 hr usage and up to 3x switching on and off

every day. In the worst case this could mean 25,000 switches at a regular rate 2 hrs on, 2 hrs off. For a 100,000 hr specified product, the driver has to survive twice the number of switches. For the electrical stresses during switching there is no problem switching many more times, even up to >100,000 times. However for the solder joints there can be a risk for the lifetime of the product.

Impact of thermal cycles per day on the driver lifetime

As the drivers are typically designed to withstand 3 full thermal cycles every day, lifetime will reduce with an increasing cycling frequency. However this reduction will be limited by the heating time of the product in the application. As the heating time of a driver in real applications varies typically between 60 and 120 minutes, maximum and minimum driver temperature will not be reached when the cycling frequency is faster than 60 minutes. Because the solder-joint damage relates to a higher power of the temperature difference between hot and cold condition, the negative effect on lifetime reduces for the higher cycling frequencies. This is expressed in the above graph.

Because of the large variation and differentiation between drivers and applications, it is an impossible task to specify the above graph for every driver and application specifically. Therefore only the critical conditions are listed for which there could be a risk to the cycling lifetime of the driver.

Critical conditions for the driver lifetime due to thermal cycling are:

- Small driver / system (short heating time) without appropriate heat sinking (high T_{max}).
- Large difference between T_{max} and temperature in off state T_{min} (e.g. $> 50\text{ }^{\circ}\text{C}$). See also next paragraph.
- Application @ temperatures $< -20\text{ }^{\circ}\text{C}$ $T_{ambient}$.

Especially if the above parameters occur in combination with each other there can be a risk for thermal cycling lifetime. To improve cycling lifetime when required, it is most relevant to decrease the T_{max} by appropriate heat sinking of the driver. As a rule of thumb $10\text{ }^{\circ}\text{C}$ diminished ΔT between T_{case} on/off, will add 30% to cycling performance.

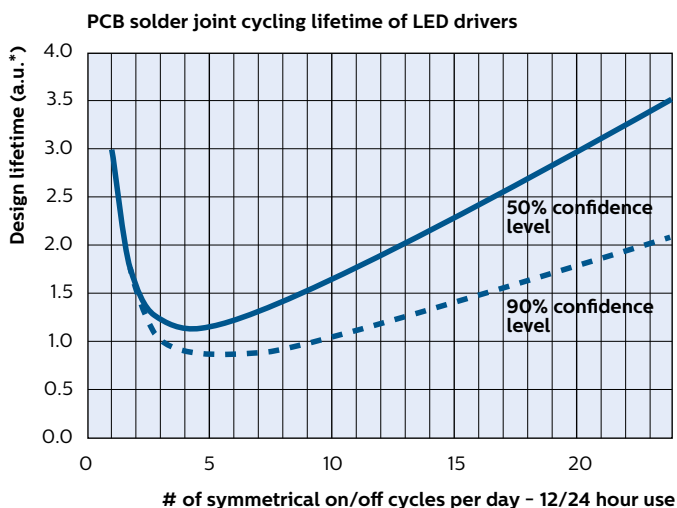

*) arbitrary unit value 1.0 means product design - lifetime will be reached (typical 50,000 h). Longer lifetimes can be limited by other failure modes.

Impact of product ambient temperature on cycling performance

In the first approximation the solder joint lifetime is independent of the ambient temperature. The driving parameter for the solder joint failure fatigue is the temperature difference between T_{max} during the 'on' state and T_{min} during the 'off' state. The way the driver is built in to a luminaire is very important as this can decrease the temperature difference. Appropriate heat sinking of the driver is the most effective way to improve the driver cycling lifetime. As a rule of thumb 10 °C diminished ΔT between T_{case on/off}, will add 30% to cycling performance.

For potted products additional failure mechanisms can occur at temperatures <-20 °C, which can increase the impact of thermal cycling on the product lifetime.

Standards the drivers are tested against

The tables below state the standards the drivers are tested against. Consequently the drivers do carry CE and ENEC, as stated in the driver's datasheet.

Compliance and approval	Generated disturbances, EMI and EMC
EN 55015 A2/CISPR15	Conducted EMI 9 kHz-30 MHz
EN 55015 A2/CISPR15	Radiated EMI 30 MHz-300 MHz
IEC 61000-3-2 A1 + A2	Limits for harmonic current emissions
IEC 61000-3-3	EMC – Limitation of voltage fluctuation and flicker in low voltage supply systems for equipment rated up to 16 A
Immunity	Generated disturbances, EMI and EMC
IEC / EN 61547, A12000	Equipment for general lighting purposes – EMC immunity requirements
IEC / EN 61000-4-2	Electrostatic Discharge
IEC / EN 61000-4-3 A1	Radiated radio frequency, electromagnetic field immunity
IEC / EN 61000-4-4	Electrical fast transient/burst immunity
IEC / EN 61000-4-5	Surge immunity
IEC / EN 61000-4-6	Conducted disturbances induced by RF fields
IEC / EN 61000-4-11	Voltage dips, short interrupts, voltage variations
Performance	Generated disturbances, EMI and EMC
IEC 62384	DC or AC supplied electronic control gear for LED modules - Performance requirements
IEC 62386	Digital Addressable Lighting Interface (DALI)
Safety standards	Generated disturbances, EMI and EMC
IEC 61347-1	General and safety requirements
IEC 61347-2-13	LED Particular requirements for DC or AC supplied electronic control gears for LED modules
Emergency standards	Generated disturbances, EMI and EMC
IEC 61347-2-3	Particular additional safety requirement for AC/DC supplied electronic ballasts for emergency lighting
IEC 61347-2-7	Particular requirements for DC supplied electronic ballasts for emergency lighting

Disclaimer

Philips will perform the testing of the LED systems to high standards of workmanship. The tests are carried out with reference to the EN/IEC standards, if any, which are regarded by Philips as being of major importance for the application of the lamp gear and the lamp within the fixture for horticultural applications.

The design-in guide, regarding the testing and design in of the LED system provided by Philips, is not an official testing certificate, and cannot be regarded as a document for official release of the fixture. The OEM is liable for the official testing by a certified test body and all markings, such as CE and ENEC marks, on the fixture assembly.

The design-in guide is for information purposes only and may contain recommendations for detecting weak points in the design of the system (lamp – lamp gear – fixture), if any.

Specifically mentioned materials and/or tools from third parties are only indicative: other equivalent equipment may be used but it is recommended that you contact Philips for verification.

Philips will not be liable for unforeseen interactions of the proposed solutions when applied in the fixtures or applications using these fixtures. Philips has not investigated whether the recommendations are or will in the future be in conflict with existing patents or any other intellectual property right. Philips does not warrant that its recommendations are technically or commercially the best options.

Since the tests are only performed on one particular fixture provided by the customer, it will be treated as a prototype. This means that there is no statistical evidence regarding later production quality and performance of the lamp – lamp gear – fixture system.

As Philips does not have control over manufacturing of the fixtures, Philips cannot be held liable for the fixture assembly.

Philips will not accept claims for any damage caused by implementing the recommendations.

No warranty whatsoever may be claimed by the OEM with regard to the content and/or quality of the design-in guide or any other advice, or the conclusions and/or recommendations in the design-in guide or any other document, either express or implied, and Philips expressly disclaims any implied warranties of any kind, including without limitation any warranties of satisfactory quality, fitness for a particular purpose or non-infringement and any warranties regarding the design-in guide or any other advice or the use of the results of any activity performed while testing the fixture with respect to its correctness, quality, accuracy, completeness, reliability, performance or otherwise.

The OEM expressly agrees that test design-in guides are provided by Philips on an 'as is' basis and an 'as available' basis at customer's sole risk and expense. Philips shall not be liable for any lost profits or lost savings, indirect, incidental, punitive, special, or consequential damages whether or not such damages are based on tort, warranty, contract, or any other legal theory – even if Philips has been advised, or is aware, of the possibility of such damages.

The OEM must bring any claim for damages within ninety (90) days of the day of the event giving rise to any such claim, and all lawsuits relative to any such claim.

